



www.hy-lok.com

Catalog No. H-310PF
May 2016

Forged Fittings

Socket Welding and Threaded - ASME B16.11



HY-LOK CORPORATION

©2001, 2013, 2016 HY-LOK CORPORATION All rights reserved



Forged Fittings

Information

4-7

90° Elbow
SWLA



8-10

Cap
SWCA

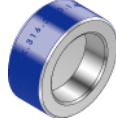

11-13

Tee
STA



19-21

Tee
SWTA

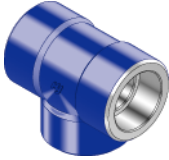

8-10

Boss Type A
SWBA

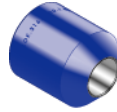

14

Boss Type R
SWBR

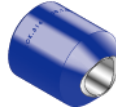

45° Elbow
SLB



19-21

45° Elbow
SWLB

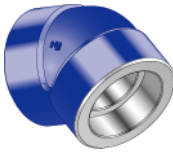

8-10

Reducing Insert
SWRM



15-16

Cross
SXA

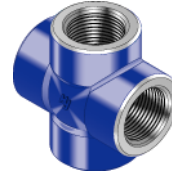

19-21

Cross
SWXA



8-10

Union
SWUR

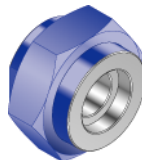

17

Street Elbows
SLC



22-23

Full Coupling
SWFC

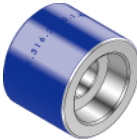

11-13

Socketlets
SWOL



18

Full Coupling
SFC

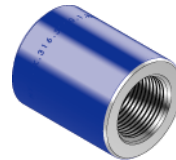

24-25

Half Coupling
SWHC



11-13

90° Elbow
SLA



19-21

Half Coupling
SHC

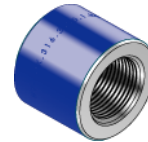

24-25

Cap
SCA

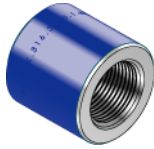

24-25

Union
SUR

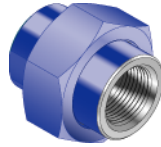

28

Hex Reducing Nipple
H-SNR

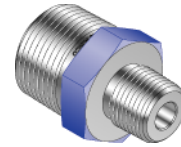

32

Boss Type A
SBA

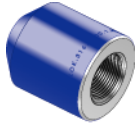

Boss Type R
SBR

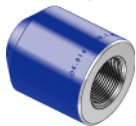

26

Nipple Outlet
SNOL



29

Hollow Hex Plug
H-SPA



33

Square Head Plug
H-SPD

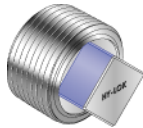

27

Plain Nipple Outlet
SPOL



29

Hex Head Plug
H-SPC

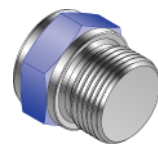

33

Hex Head Plug
H-SPB

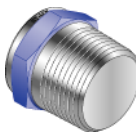

27

Swaged Nipple



30

Blanking Plugs with ED-Ring for Ports
DVSTI-GED/MED



34

Round Head Plug
H-SPR



27

Thredolets
SOL

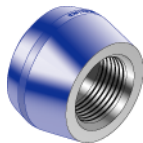

31

Blanking Plugs with O-Ring for Ports
DVSTI

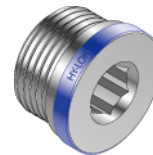

34

Hex Head Bushing
H-SHB

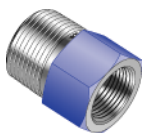

27

Hex Nipple
H-SNA

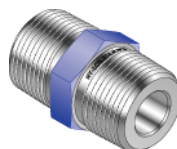

32

Seal & Condensate Pot
ASCP

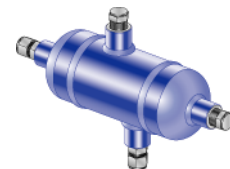

35

Reference

36-39

Scope

This catalog covers ratings, dimensions, tolerances, marking, and material requirements for forged fittings, both socket-welding and threaded by ASME B16.11 and NORSOK Spec Class AG70, Union, Reducing Insert and Swaged Nipples by MSS Standard and BS3799 with some additions such as outlets.

Pressure Ratings

General

Fittings under this catalog shall be designated as class 2000, 3000, and 6000 for threaded end fittings and class 3000, 6000, and 9000 for socket-weld end fittings.

Basic of Rating

The schedule of pipe corresponding to each class designation of fitting for rating purposes is shown in Table 1.

| Class Designation of Fittings | Type of Fitting | Pipe Used for Rating Basis ^① | |
|-------------------------------|------------------|---|------------------|
| | | Schedule No. | Wall Designation |
| 2000 | Threaded | 80 | XS |
| 3000 | | 160 | - |
| 6000 | | - | XXS |
| 3000 | Socket - welding | 80 | XS |
| 6000 | | 160 | - |
| 9000 | | - | XXS |

Note : ^① This table is not intended to restrict the use of pipe of thinner or thicker wall with fittings. Actually pipe may be thinner or thicker in nominal wall than that shown in Table 1. When thinner pipe is used, its strength may govern the rating. When thicker pipe is used (e.g., for mechanical strength), the strength of the fitting govern the rating.

Nonstandard Pipe Wall Thickness

Since ASME B36.10M does not include Schedule 160 nor Double Extra Strong thickness for NPS 1/8, 1/4, and 3/8, the values in Table 2 shall be used as the nominal wall thicknesses of the pipe for rating purposes.

Table 2. Nominal Wall Thickness of Schedule 160 and Double Extra Strong Pipe

| NPS | Schedule 160 | | XXS | |
|-----|--------------|-------|------|-------|
| | mm | in. | mm | in. |
| 1/8 | 3.15 | 0.124 | 4.83 | 0.190 |
| 1/4 | 3.68 | 0.145 | 6.05 | 0.238 |
| 3/8 | 4.01 | 0.158 | 6.40 | 0.252 |

Combination End Fittings

The class for fittings made with combinations of socket-welding and threaded ends shall be based on the end configuration that has the lowest rating from Table 1

Pressure Test Capability

Pressure testing is not required by these products, but the fittings of withstanding a hydrostatic test pressure required by applicable piping code for seamless pipe of material equivalent to the fitting forging and of the schedule or wall thickness correlated with the fitting class and end connection of Table 1.

Size and Type

General

NPS, followed by a dimensionless number, is the designation for nominal fitting size.

NPS is related to the reference nominal diameter, DN, used in international standards.

The relationship is typically as follows:

| | | | | | | | | | | | | |
|-----|-----|-----|-----|-----|-----|----|-------|-------|----|-------|----|-----|
| NPS | 1/8 | 1/4 | 3/8 | 1/2 | 3/4 | 1 | 1 1/4 | 1 1/2 | 2 | 2 1/2 | 3 | 4 |
| DN | 6 | 8 | 10 | 15 | 20 | 25 | 32 | 40 | 50 | 65 | 80 | 100 |

Reducing Fitting Size

In the case of reducing tees and crosses, the size of the largest run opening shall be given first, followed by the size of the opening at the opposite end of the run. Where the fitting is a tee, the size of the branch is given last.

Where the fitting is a cross, the largest side-outlet is the third dimension given, followed by the opening opposite.

The line sketches, Fig. 1, illustrate how the reducing fittings are read.

Fig. 1 Method of Designating Outlets of Reducing Tees and Crosses

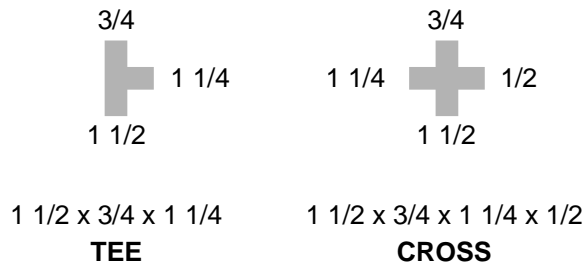

Fitting Types

Types of fittings covered by this catalog are shown in Table 3, by class and size range.

| Description | Socket - Welding | | | Threaded | | |
|---|-------------------|-------|-------|-------------------|---------|-------|
| | Class Designation | | | Class Designation | | |
| | 3000 | 6000 | 9000 | 2000 | 3000 | 6000 |
| 45-deg, 90-deg elbows, tees, crosses, | 1/8-4 | 1/8-2 | 1/2-2 | 1/8-4 | 1/8-4 | 1/8-4 |
| couplings, half-couplings, and caps | 1/8-4 | 1/8-2 | 1/2-2 | - | 1/8-4 | 1/8-4 |
| Street elbows | - | - | - | - | 1/8-2 | 1/8-2 |
| Square, hex, round plug, hex, and flush bushing | - | - | - | 1/8-4 ① | 1/8-4 ① | 1/8-4 |
| | - | - | - | 1/8-4 ① | 1/8-4 ① | 1/8-4 |

Note :① Plug, hex nipple and bushings are not identified by class designation. They may be used for ratings up through class 6000 designation.

Marking

General

Each fitting shall be permanently marked with the required identification by raised lettering and/or stamping, electro-etching, or vibro-tool marking on the collar portion, raised pad, or raised boss portion of the forging. Cylindrical fittings shall be marked on the O.D. or end of the fitting in a location such that the marking will not be obliterated as a result of welding installation. The marking of bushings and plugs are not required.

Specific Marking

The marking shall include (but is not limited to) the following.

- **Manufacturer's Name or Trademark**
- **Material Identification**
- **Class Designation**
- **Size**

Materials

Fittings shall be made of materials consisting of forgings, bar, seamless pipe, or seamless tubular products.

These materials shall conform to the requirements for the WP seamless construction materials of ASTM Fitting Specifications A 234, A 403, A 420, A 815, or B 366 or ASTM Forging Specifications A 105, A 182, A 350, B 462, or B 564. Tees, elbows, and crosses shall not be made from bar stock.

Super duplex stainless steel can be supply according to NORSOK M650 standard such as F53 and F51.

Dimensions

General

Unless otherwise noted, the dimensions without tolerances for socket-welding and threaded fittings given in this catalog are nominal values and subject to the designated manufacturing tolerances.

Socket Fittings

- **Body and Socket Wall Thickness**

The body and socket wall thickness of socket-welding fittings shall be equal to or greater than the values, G and C shown in this catalog.

- **Socket Depth**

The socket depth shall be no less than the minimum values, J, shown in this catalog.

- **Width**

The forging radius shall not reduce the width of the flat welding surface to less than the value shown in Fig. 2.

Fig. 2 Welding Gap and Minimum flat Dimensions for Socket - Welding Fittings

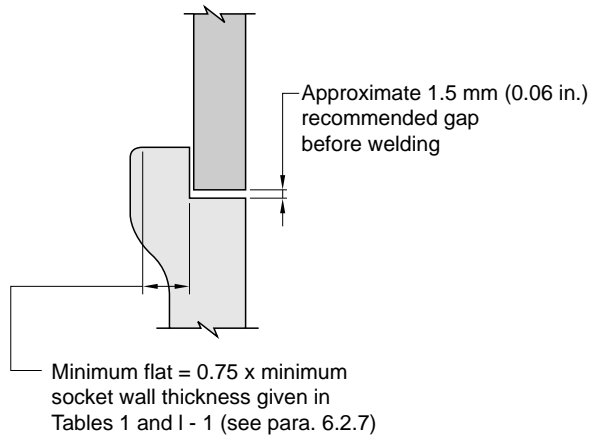

Coincidence of Axes.

The maximum allowable variation in the alignment of the fitting bore and socket bore axes shall be 1mm in 200mm (0.06 in. in 1 ft).

The maximum allowable variation in alignment of threads shall be 1 mm in 200 mm (0.06 in. in 1 ft).

Proof Testing

Proof testing for fittings made by ASME B 16.11 is not required.

Threaded Fittings.

• Wall Thickness

The body or end wall thickness of threaded fittings shall be equal to or greater than the minimum values, G, as shown in this catalog.

• Threads

All fittings with internal and external threads shall be threaded with American National Standard Taper Pipe Threads (ASME B1.20.1).

Collars

End collars of both socket-welding and threaded fittings shall be such that they overlap the crotch area as illustrated in the sketches in this catalog.

Reducing Fittings

Reducing fittings shall have the same center-to-end, center-to-bottom of socket, band diameter, and outside diameters as the uniform size fitting corresponding to the largest size end connection of the reducing fitting.

Additional Tolerances

Additional tolerances are not listed in this catalog.

Concentricity of Bores.

The socket and fitting bores shall be concentric within a tolerance of 0.8mm (0.03 in.) for all sizes. Opposite socket bores shall be concentric within a tolerance of 1.5mm (0.06 in.) for all sizes.

Ordering Information

Part Number Example

1) Socket Welding

2) Threaded

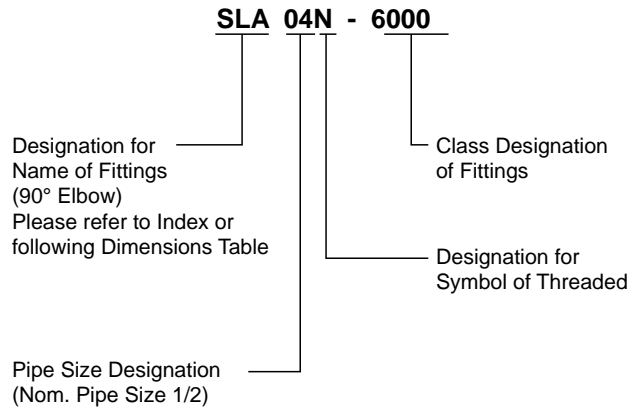
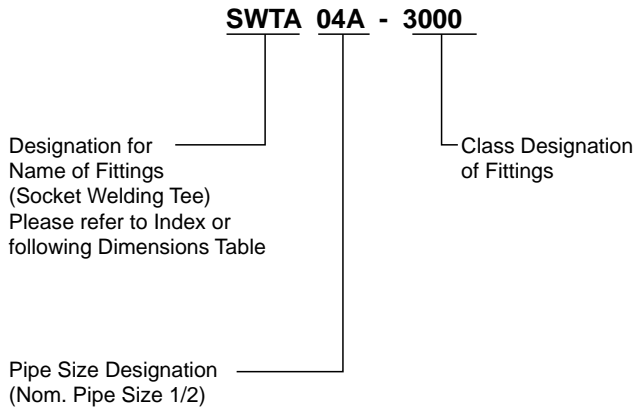

Pipe Size Designations

| | | | | | | | | | |
|----------------|-----|-----|-----|-----|-----|-----|-------|-------|-----|
| Nom. Pipe Size | 1/8 | 1/4 | 3/8 | 1/2 | 3/4 | 1 | 1 1/4 | 1 1/2 | 2 |
| Designations | 01A | 02A | 03A | 04A | 06A | 08A | 10A | 12A | 16A |

Note : In case of threaded, "A" is omitted.

Symbol of Threaded

R : Taper Pipe Thread (PT, JIS B0203, ISO 7/1)

G : Parallel Pipe Thread (PF, JIS B0202, ISO 228/1)

N : American National Standard Taper Pipe Thread (NPT, ANSI B1.20.1)



Forged Fittings

90° Elbow
SWLA

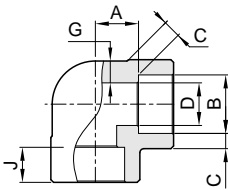

Tee
SWTA

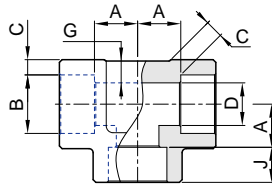
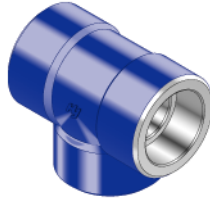

45° Elbow
SWLB

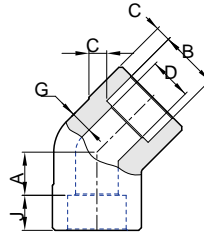
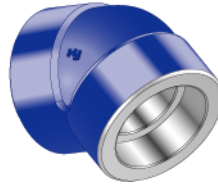

Cross
SWXA

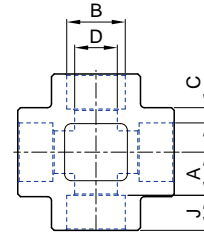
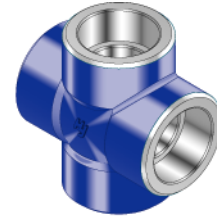

ASME B16.11

| Class Designation of Fittings | Nom. Pipe Size | DN | B Socket Bore Dia. ⁽¹⁾ | D Bore Dia. ⁽¹⁾ | Socket Wall Thk. C ⁽²⁾ | Body Wall Thk. Min. G | Depth of socket Min. J | A | A 45° Elbows |
|-------------------------------|----------------|-----|-----------------------------------|----------------------------|-----------------------------------|-----------------------|------------------------|------|--------------|
| 3000 | 1/8 | 6 | 11.2 10.8 | 7.6 6.1 | 3.18 3.18 | 2.41 | 9.5 | 11.0 | 8.0 |
| | 1/4 | 8 | 14.6 14.2 | 10.0 8.5 | 3.78 3.30 | 3.01 | 9.5 | 11.0 | 8.0 |
| | 3/8 | 10 | 18.0 17.6 | 13.3 11.8 | 4.01 3.50 | 3.20 | 9.5 | 13.5 | 8.0 |
| | 1/2 | 15 | 22.2 21.8 | 16.6 15.0 | 4.67 4.09 | 3.73 | 9.5 | 15.5 | 11.0 |
| | 3/4 | 20 | 27.6 27.2 | 21.7 20.2 | 4.90 4.27 | 3.91 | 12.5 | 19.0 | 12.5 |
| | 1 | 25 | 34.3 33.9 | 27.4 25.9 | 5.69 4.98 | 4.55 | 12.5 | 22.5 | 14.0 |
| | 1 1/4 | 32 | 43.1 42.7 | 35.8 34.3 | 6.07 5.28 | 4.85 | 12.5 | 27.0 | 17.5 |
| | 1 1/2 | 40 | 49.2 48.8 | 41.6 40.1 | 6.35 5.54 | 5.08 | 12.5 | 32.0 | 20.5 |
| | 2 | 50 | 61.7 61.2 | 53.3 51.7 | 6.93 6.04 | 5.54 | 16.0 | 38.0 | 25.5 |
| | 2 1/2 | 65 | 74.4 73.9 | 64.2 61.2 | 8.76 7.67 | 7.01 | 16.0 | 41.0 | 28.5 |
| | 3 | 80 | 90.3 89.8 | 79.4 76.4 | 9.52 8.30 | 7.62 | 16.0 | 57.0 | 32.0 |
| | 4 | 100 | 115.7 115.2 | 103.8 100.7 | 10.69 9.35 | 8.56 | 19.0 | 66.5 | 41.0 |

Note : (1) Upper and lower values for each size are the respective maximum and minimum dimensions.

(2) Average of socket wall thickness around periphery shall be no less than listed values.
The minimum values are permitted in localized areas.

All dimensions are in millimeters.

90° Elbow
SWLA

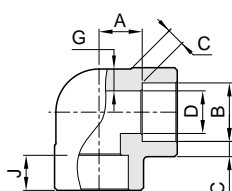

Tee
SWTA

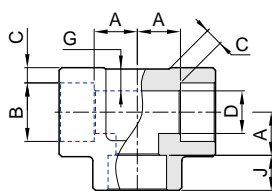
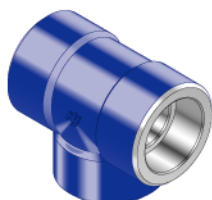

45° Elbow
SWLB

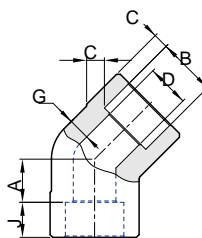
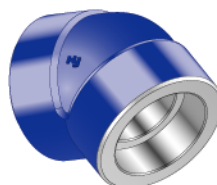

Cross
SWXA

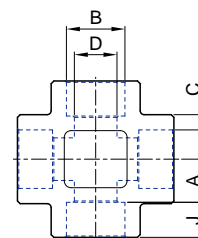
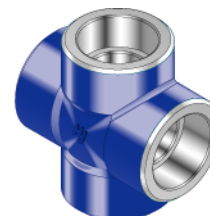

ASME B16.11

| Class Designation of Fittings | Nom. Pipe Size | DN | B Socket Bore Dia. ⁽¹⁾ | D Bore Dia. ⁽¹⁾ | Socket Wall Thk. C ⁽²⁾ | Body Wall Thk. Min. G | Depth of socket Min. J | A | A 45° Elbows |
|-------------------------------|----------------|--------------|-----------------------------------|----------------------------|-----------------------------------|-----------------------|------------------------|------|--------------|
| 6000 | 1/8 | 6 | 11.2 10.8 | 4.8 3.2 | 3.96 3.43 | 3.15 | 9.5 | 11.0 | 8.0 |
| | 1/4 | 8 | 14.6 14.2 | 7.1 5.6 | 4.60 4.01 | 3.68 | 9.5 | 13.5 | 8.0 |
| | 3/8 | 10 | 18.0 17.6 | 9.9 8.4 | 5.03 4.37 | 4.01 | 12.5 | 15.5 | 11.0 |
| | 1/2 | 15 | 22.2 21.8 | 12.5 11.0 | 5.97 5.18 | 4.78 | 9.5 | 19.0 | 12.5 |
| | 3/4 | 20 | 27.6 27.2 | 16.3 14.8 | 6.96 6.04 | 5.56 | 12.5 | 22.5 | 14.0 |
| | 1 | 25 | 34.3 33.9 | 21.5 19.9 | 7.92 6.93 | 6.35 | 12.5 | 27.0 | 17.5 |
| | 1 1/4 | 32 | 43.1 42.7 | 30.2 28.7 | 7.92 6.93 | 6.35 | 12.5 | 32.0 | 20.5 |
| | 1 1/2 | 40 | 49.2 48.8 | 34.7 33.2 | 8.92 7.80 | 7.14 | 12.5 | 38.0 | 25.5 |
| 2 | 50 | 61.7 61.2 | 43.6 42.1 | 10.92 9.50 | 8.74 | 16.0 | 41.0 | 28.5 | |

Note : (1) Upper and lower values for each size are the respective maximum and minimum dimensions.
 (2) Average of socket wall thickness around periphery shall be no less than listed values.
 The minimum values are permitted in localized areas.

Forged Fittings

90° Elbow
SWLA

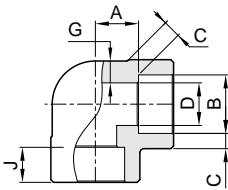
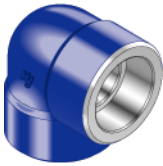

Tee
SWTA

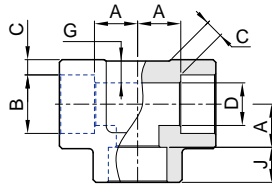
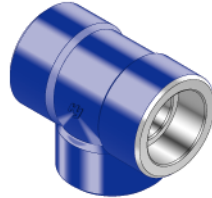

45° Elbow
SWLB

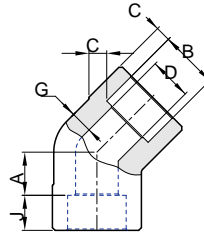
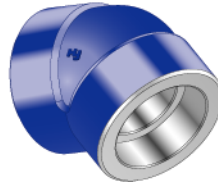

Cross
SWXA

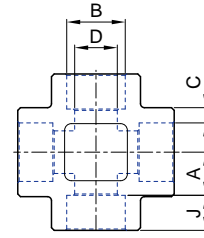
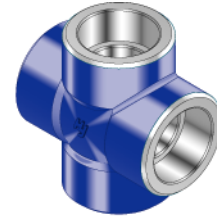

ASME B16.11

| Class Designation of Fittings | Nom. Pipe Size | DN | B Socket Bore Dia. ⁽¹⁾ | D Bore Dia. ⁽¹⁾ | Socket Wall Thk. C ⁽²⁾ | Body Wall Thk. Min. G | Depth of socket Min. J | A | A 45° Elbows |
|-------------------------------|----------------|----|-----------------------------------|----------------------------|-----------------------------------|-----------------------|------------------------|------|--------------|
| 9000 | 1/2 | 15 | 22.2 21.8 | 7.2 5.6 | 9.35 8.18 | 7.47 | 9.5 | 25.5 | 15.5 |
| | 3/4 | 20 | 27.6 27.2 | 11.8 10.3 | 9.78 8.56 | 7.82 | 12.5 | 28.5 | 19.0 |
| | 1 | 25 | 34.3 33.9 | 16.0 14.4 | 11.38 9.96 | 9.09 | 12.5 | 32.0 | 20.5 |
| | 1 1/4 | 32 | 43.1 42.7 | 23.5 22.0 | 12.14 10.62 | 9.70 | 12.5 | 35.0 | 22.5 |
| | 1 1/2 | 40 | 49.2 48.8 | 28.7 27.2 | 12.70 11.12 | 10.15 | 12.5 | 38.0 | 25.5 |
| | 2 | 50 | 61.7 61.2 | 38.9 37.4 | 13.84 12.12 | 11.07 | 16.0 | 54.0 | 28.5 |

Note : (1) Upper and lower values for each size are the respective maximum and minimum dimensions.
 (2) Average of socket wall thickness around periphery shall be no less than listed values.
 The minimum values are permitted in localized areas.

Full Coupling
SWFC

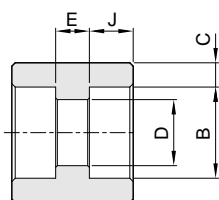
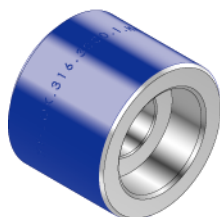

Half Coupling
SWHC

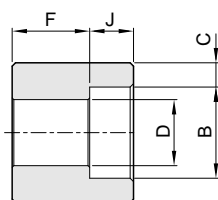

Cap
SWCA

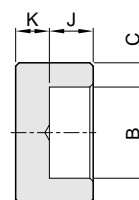
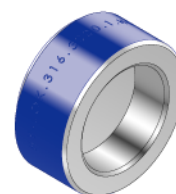

ASME B16.11

| Class Designation of Fittings | Nom. Pipe Size | DN | B Socket Bore Dia. ⁽¹⁾ | D Bore Dia. ⁽¹⁾ | Socket Wall Thk. C ⁽²⁾ | Depth of socket Min. J | E | F | K Min. |
|-------------------------------|----------------|----------------|-----------------------------------|----------------------------|-----------------------------------|------------------------|------|------|--------|
| 3000 | 1/8 | 6 | 11.2 10.8 | 7.6 6.1 | 3.18 3.18 | 9.5 | 6.5 | 16.0 | 4.8 |
| | 1/4 | 8 | 14.6 14.2 | 10.0 8.5 | 3.78 3.30 | 9.5 | 6.5 | 16.0 | 4.8 |
| | 3/8 | 10 | 18.0 17.6 | 13.3 11.8 | 4.01 3.50 | 9.5 | 6.5 | 17.5 | 4.8 |
| | 1/2 | 15 | 22.2 21.8 | 16.6 15.0 | 4.67 4.09 | 9.5 | 9.5 | 22.5 | 6.4 |
| | 3/4 | 20 | 27.6 27.2 | 21.7 20.2 | 4.90 4.27 | 12.5 | 9.5 | 24.0 | 6.4 |
| | 1 | 25 | 34.3 33.9 | 27.4 25.9 | 5.69 4.98 | 12.5 | 12.5 | 28.5 | 9.6 |
| | 1 1/4 | 32 | 43.1 42.7 | 35.8 34.3 | 6.07 5.28 | 12.5 | 12.5 | 30.0 | 9.6 |
| | 1 1/2 | 40 | 49.2 48.8 | 41.6 40.1 | 6.35 5.54 | 12.5 | 12.5 | 32.0 | 11.2 |
| | 2 | 50 | 61.7 61.2 | 53.3 51.7 | 6.93 6.04 | 16.0 | 19.0 | 41.0 | 12.7 |
| | 2 1/2 | 65 | 74.4 73.9 | 64.2 61.2 | 8.76 7.67 | 16.0 | 19.0 | 43.0 | 15.7 |
| | 3 | 80 | 90.3 89.8 | 79.4 76.4 | 9.52 8.30 | 16.0 | 19.0 | 44.5 | 19.0 |
| 4 | 100 | 115.7 115.2 | 103.8 100.7 | 10.69 9.35 | 19.0 | 19.0 | 48.0 | 22.4 | |

Note : (1) Upper and lower values for each size are the respective maximum and minimum dimensions.

(2) Average of socket wall thickness around periphery shall be no less than listed values.

The minimum values are permitted in localized areas.

All dimensions are in millimeters.

Forged Fittings

Full Coupling SWFC

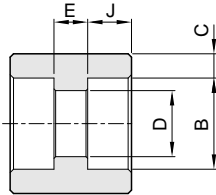

Half Coupling SWHC

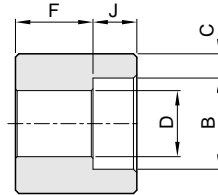

Cap SWCA

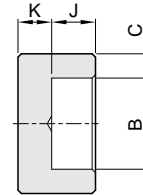

ASME B16.11

| Class Designation of Fittings | Nom. Pipe Size | DN | B Socket Bore Dia. ⁽¹⁾ | D Bore Dia. ⁽¹⁾ | Socket Wall Thk. C ⁽²⁾ | Depth of socket Min. J | E | F | K Min. |
|-------------------------------|----------------|----|-----------------------------------|----------------------------|-----------------------------------|------------------------|------|------|--------|
| 6000 | 1/8 | 6 | 11.2 10.8 | 4.8 3.2 | 3.96 3.43 | 9.5 | 6.5 | 16.0 | 6.4 |
| | 1/4 | 8 | 14.6 14.2 | 7.1 5.6 | 4.60 4.01 | 9.5 | 6.5 | 16.0 | 6.4 |
| | 3/8 | 10 | 18.0 17.6 | 9.9 8.4 | 5.03 4.37 | 12.5 | 6.5 | 17.5 | 6.4 |
| | 1/2 | 15 | 22.2 21.8 | 12.5 11.0 | 5.97 5.18 | 9.5 | 9.5 | 22.5 | 7.9 |
| | 3/4 | 20 | 27.6 27.2 | 16.3 14.8 | 6.96 6.04 | 12.5 | 9.5 | 24.0 | 7.9 |
| | 1 | 25 | 34.3 33.9 | 21.5 19.9 | 7.92 6.93 | 12.5 | 12.5 | 28.5 | 11.2 |
| | 1 1/4 | 32 | 43.1 42.7 | 30.2 28.7 | 7.92 6.93 | 12.5 | 12.5 | 30.0 | 11.2 |
| | 1 1/2 | 40 | 49.2 48.8 | 34.7 33.2 | 8.92 7.80 | 12.5 | 12.5 | 32.0 | 12.7 |
| | 2 | 50 | 61.7 61.2 | 43.6 42.1 | 10.92 9.50 | 16.0 | 19.0 | 41.0 | 15.7 |

Note : (1) Upper and lower values for each size are the respective maximum and minimum dimensions.

(2) Average of socket wall thickness around periphery shall be no less than listed values.
The minimum values are permitted in localized areas.

Full Coupling
SWFC

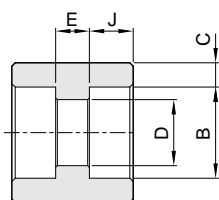

Half Coupling
SWHC

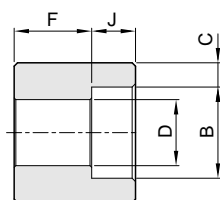

Cap
SWCA

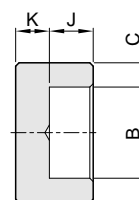
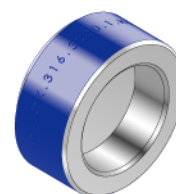

ASME B16.11

| Class Designation of Fittings | Nom. Pipe Size | DN | B Socket Bore Dia. ⁽¹⁾ | D Bore Dia. ⁽¹⁾ | Socket Wall Thk. C ⁽²⁾ | Depth of socket Min. J | E | F | K Min. |
|-------------------------------|----------------|----|-----------------------------------|----------------------------|-----------------------------------|------------------------|------|------|--------|
| 9000 | 1/2 | 15 | 22.2 21.8 | 7.2 5.6 | 9.35 8.18 | 9.5 | 9.5 | 22.5 | 11.2 |
| | 3/4 | 20 | 27.6 27.2 | 11.8 10.3 | 9.78 8.56 | 12.5 | 9.5 | 24.0 | 12.7 |
| | 1 | 25 | 34.3 33.9 | 16.0 14.4 | 11.38 9.96 | 12.5 | 12.5 | 28.5 | 14.2 |
| | 1 1/4 | 32 | 43.1 42.7 | 23.5 22.0 | 12.14 10.62 | 12.5 | 12.5 | 30.0 | 14.2 |
| | 1 1/2 | 40 | 49.2 48.8 | 28.7 27.2 | 12.70 11.12 | 12.5 | 12.5 | 32.0 | 15.7 |
| | 2 | 50 | 61.7 61.2 | 38.9 37.4 | 13.84 12.12 | 16.0 | 19.0 | 41.0 | 19.0 |

Note : (1) Upper and lower values for each size are the respective maximum and minimum dimensions.

(2) Average of socket wall thickness around periphery shall be no less than listed values.

The minimum values are permitted in localized areas.

Forged Fittings

Boss Type A SWBA

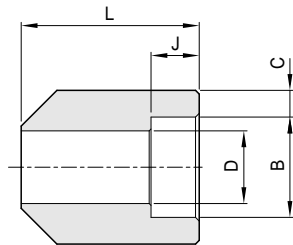
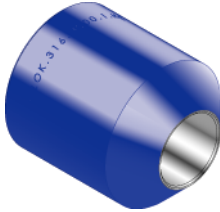

Boss Type R SWBR

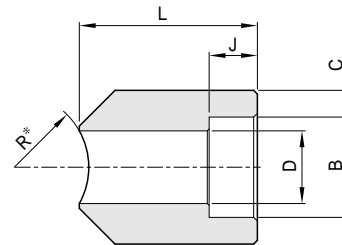
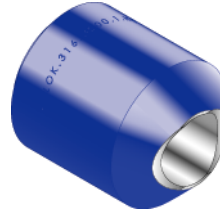

ASME B16.11

| Class Designation of Fittings | Nom. Pipe Size | B Socket Bore Dia. ⁽¹⁾ | D Bore Dia. ⁽¹⁾ | Socket Wall Thk. C ⁽²⁾ | Depth of socket Min. J | L |
|-------------------------------|----------------|-----------------------------------|----------------------------|-----------------------------------|------------------------|----|
| 3000 | 1/4 | 14.6 | 10.0 | 3.78 | 9.5 | 40 |
| | | 14.2 | 8.5 | 3.30 | | |
| | 3/8 | 18.0 | 13.3 | 4.01 | 9.5 | 50 |
| | | 17.6 | 11.8 | 3.50 | | |
| | 1/2 | 22.2 | 16.6 | 4.67 | 9.5 | 50 |
| | | 21.8 | 15.0 | 4.09 | | |
| | 3/4 | 27.6 | 21.7 | 4.90 | 12.5 | 50 |
| | | 27.2 | 20.2 | 4.27 | | |
| 1 | 34.3 | 27.4 | 5.69 | 12.5 | 50 | |
| | 33.9 | 25.9 | 4.98 | | | |
| 1 1/4 | 43.1 | 35.8 | 6.07 | 12.5 | 50 | |
| | 42.7 | 34.3 | 5.28 | | | |
| 1 1/2 | 49.2 | 41.6 | 6.35 | 12.5 | 50 | |
| | 48.8 | 40.1 | 5.54 | | | |
| 2 | 61.7 | 53.3 | 6.93 | 16.0 | 60 | |
| | 61.2 | 51.7 | 6.04 | | | |
| 6000 | 1/2 | 22.2 | 12.5 | 5.97 | 9.5 | 50 |
| | | 21.8 | 11.0 | 5.18 | | |
| | 3/4 | 27.6 | 16.3 | 6.96 | 12.5 | 50 |
| | | 27.2 | 14.8 | 6.04 | | |
| | 1 | 34.3 | 21.5 | 7.92 | 12.5 | 50 |
| | | 33.9 | 19.9 | 6.93 | | |
| | 1 1/4 | 43.1 | 30.2 | 7.92 | 12.5 | 50 |
| | | 42.7 | 28.7 | 6.93 | | |
| 1 1/2 | 49.2 | 34.7 | 8.92 | 12.5 | 50 | |
| | 48.8 | 33.2 | 7.80 | | | |
| 2 | 61.7 | 43.6 | 10.92 | 16.0 | 50 | |
| | 61.2 | 42.1 | 9.50 | | | |

Note : * is run pipe sizes

Example : SWBR06A-3000-R34 / S316 - 3/4" NPS CL3000 Run pipe 34.0mm O.D

(1) Upper and lower values for each size are the respective maximum and minimum dimensions.

(2) Average of socket wall thickness around periphery shall be no less than listed values.

The minimum values are permitted in localized areas.

Dimensions are in millimeters.

Reducing Insert
SWRM

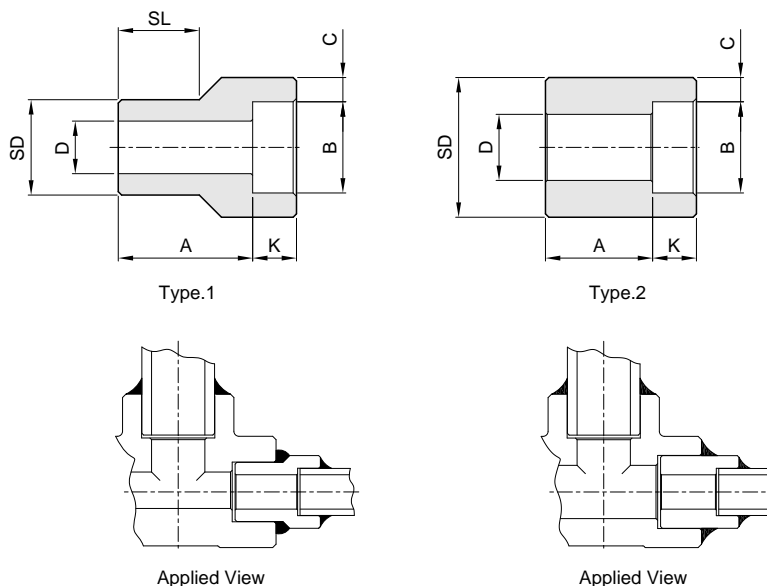

MSS SP-79

| Class Designation of Fittings | Nominal Pipe Size | Type | Socket | | Shank Dia. SD | Laying Length A | Bore D | Wall MIN. C | Length |
|-------------------------------|-------------------|-------|--------|--------------|---------------|-----------------|--------|-------------|--------|
| | | | Dia. B | Depth Min. K | | | | | SL |
| 3000 | 3/8 x 1/4 | 1 | 14.35 | 10 | 17.15 | 19 | 9.0 | 3.78 | 14 |
| | 1/2 x 1/4 | 2 | 14.35 | 10 | 21.34 | 21 | 9.0 | 3.78 | 16 |
| | 1/2 x 3/8 | 1 | 17.78 | 10 | 21.34 | 21 | 12.5 | 4.01 | 16 |
| | 3/4 x 1/4 | 2 | 14.35 | 10 | 26.67 | 18 | 9.0 | 3.78 | - |
| | 3/4 x 3/8 | 2 | 17.78 | 10 | 26.67 | 16 | 12.5 | 4.01 | - |
| | 3/4 x 1/2 | 1 | 21.97 | 10 | 26.67 | 22 | 16.0 | 4.67 | 17 |
| | 1 x 3/8 | 2 | 17.78 | 10 | 33.40 | 18 | 12.5 | 4.01 | - |
| | 1 x 1/2 | 2 | 21.97 | 10 | 33.40 | 16 | 16.0 | 4.67 | - |
| | 1 x 3/4 | 1 | 27.31 | 13 | 33.40 | 24 | 21.0 | 4.90 | 19 |
| | 1 1/4 x 1/2 | 2 | 21.97 | 10 | 42.16 | 19 | 16.0 | 4.67 | - |
| | 1 1/4 x 3/4 | 2 | 27.31 | 13 | 42.16 | 18 | 21.0 | 4.90 | - |
| | 1 1/4 x 1 | 1 | 34.04 | 13 | 42.16 | 25 | 26.5 | 5.69 | 21 |
| | 1 1/2 x 3/4 | 2 | 27.31 | 13 | 48.26 | 19 | 21.0 | 4.90 | - |
| | 1 1/2 x 1 | 2 | 34.04 | 13 | 48.26 | 18 | 26.5 | 5.69 | - |
| | 1 1/2 x 1 1/4 | 1 | 42.80 | 13 | 48.26 | 28 | 35.0 | 6.07 | 22 |
| | 2 x 1 | 2 | 34.04 | 13 | 60.32 | 22 | 26.5 | 5.69 | - |
| 2 x 1 1/4 | 2 | 42.80 | 13 | 60.32 | 21 | 35.0 | 6.07 | - | |
| 2 x 1 1/2 | 1 | 48.90 | 13 | 60.32 | 32 | 41.0 | 6.35 | 25 | |

All dimensions are in millimeters.

Reducing Insert SWRM

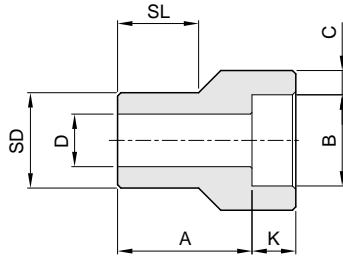

Type.1

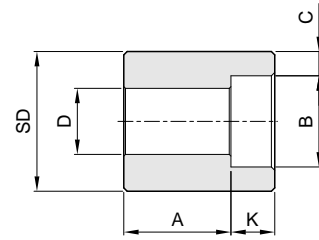

Type.2

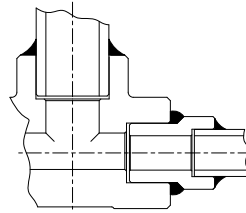

Applied View

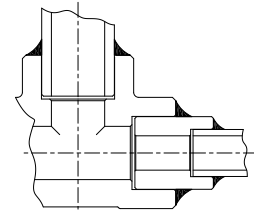

Applied View

MSS SP-79

| Class Designation of Fittings | Nominal Pipe Size | Type | Socket | | Shank DIA. SD | Laying Length A | Bore D | Wall MIN. C | Length |
|-------------------------------|-------------------|------|--------|--------------|---------------|-----------------|--------|-------------|--------|
| | | | DIA. B | Depth Min. K | | | | | SL |
| 6000 | 3/4 x 1/4 | 2 | 14.35 | 10 | 26.67 | 22 | 6.5 | 4.60 | - |
| | 1 x 1/2 | 1 | 21.97 | 10 | 33.40 | 28 | 11.5 | 5.97 | 21 |
| | 1 x 3/4 | 1 | 27.31 | 13 | 33.40 | 28 | 15.5 | 6.96 | 21 |
| | 1 1/4 x 1/2 | 2 | 21.97 | 10 | 42.16 | 22 | 11.5 | 5.97 | - |
| | 1 1/4 x 3/4 | 2 | 27.31 | 13 | 42.16 | 21 | 15.5 | 6.96 | - |
| | 1 1/4 x 1 | 1 | 34.04 | 13 | 42.16 | 30 | 20.5 | 7.92 | 22 |
| | 1 1/2 x 3/4 | 2 | 27.31 | 13 | 48.26 | 25 | 15.5 | 6.96 | - |
| | 1 1/2 x 1 | 1 | 34.04 | 13 | 48.26 | 29 | 20.5 | 7.92 | 25 |
| | 1 1/2 x 1 1/4 | 1 | 42.80 | 13 | 48.26 | 35 | 29.5 | 7.92 | 25 |
| | 2 x 1 | 2 | 34.04 | 13 | 60.32 | 25 | 21.0 | 7.92 | - |
| | 2 x 1 1/4 | 2 | 42.80 | 13 | 60.32 | 24 | 29.5 | 7.92 | - |
| | 2 x 1 1/2 | 1 | 48.90 | 13 | 60.32 | 47 | 34.0 | 8.90 | 40 |

All dimensions are in millimeters.

Union
SWUR

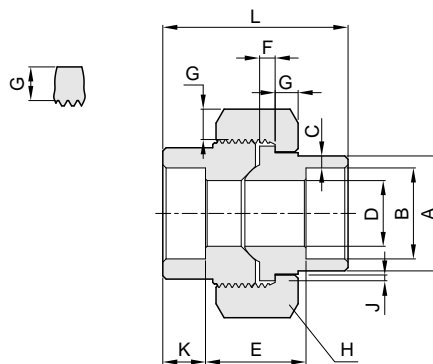
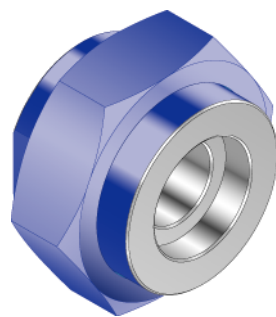

MSS SP-83

| Nom. Pipe Size | DN | Pipe End Min. | Socket Bore Dia. | Socket Wall Min. | Water Way Bore | Laying Length | Male Flange Min. | Nut Min. | Bearing Min. | Depth of Socket Min. | Length Assem. Normal | Width Flats |
|----------------|----|---------------|------------------|------------------|----------------|---------------|------------------|----------|--------------|----------------------|----------------------|-------------|
| | | A | B | C | D | E | F | G | J | K | L | H |
| 1/8 | 6 | 21.8 | 11.18 10.67 | 3.18 | 7.59 6.07 | 22.4 19.0 | 3.17 | 3.17 | 1.24 | 9.6 | 41.1 | HEX. 30.0 |
| 1/4 | 8 | 21.8 | 14.61 14.10 | 3.30 | 10.01 8.48 | 22.4 19.0 | 3.17 | 3.17 | 1.24 | 9.6 | 41.4 | HEX. 36.0 |
| 3/8 | 10 | 25.9 | 18.03 17.53 | 3.51 | 13.28 11.76 | 26.9 20.6 | 3.43 | 3.43 | 1.37 | 9.6 | 46.0 | HEX. 41.0 |
| 1/2 | 15 | 31.2 | 22.23 21.72 | 4.09 | 16.56 15.04 | 26.9 20.6 | 3.68 | 3.68 | 1.50 | 9.6 | 49.0 | HEX. 46.0 |
| 3/4 | 20 | 37.1 | 27.56 27.05 | 4.27 | 21.69 20.17 | 31.8 25.4 | 4.06 | 4.06 | 1.68 | 12.7 | 56.9 | HEX. 55.0 |
| 1 | 25 | 45.5 | 34.29 33.78 | 4.98 | 27.41 25.88 | 34.3 26.2 | 4.57 | 4.44 | 1.85 | 12.7 | 62.0 | HEX. 60.0 |
| 1 1/4 | 32 | 54.9 | 43.05 42.55 | 5.28 | 35.81 34.29 | 40.6 32.5 | 5.33 | 5.21 | 2.13 | 12.7 | 71.1 | OCT. 75.0 |
| 1 1/2 | 40 | 61.5 | 49.15 48.64 | 5.54 | 41.66 40.13 | 42.2 34.0 | 5.84 | 5.59 | 2.31 | 12.7 | 76.5 | OCT. 85.0 |
| 2 | 50 | 75.2 | 61.62 61.11 | 6.05 | 53.26 51.74 | 45.5 37.3 | 6.60 | 6.35 | 2.69 | 15.8 | 86.1 | OCT. 94.0 |

All dimensions are in millimeters.

Forged Fittings

Socketlets SWOL

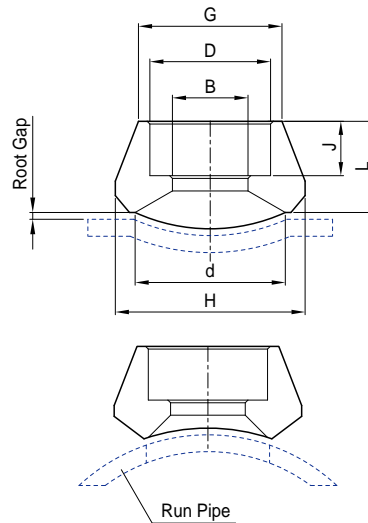
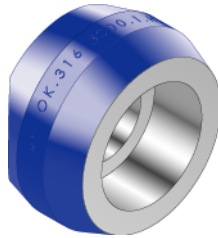

| Class Designation of Fittings | Nom. Pipe Size | DN | B Socket Bore Dia. ¹⁾ | D Bore Dia. | G | H | d | Depth of socket Min. J | L |
|-------------------------------|----------------|----|----------------------------------|--------------|------|-------|------|------------------------|------|
| 3000 | 1/2 | 15 | 22.2 21.8 | 16.6 15.0 | 31.8 | 35.7 | 23.0 | 9.5 | 25.4 |
| | 3/4 | 20 | 27.6 27.2 | 21.7 20.2 | 36.6 | 43.7 | 29.4 | 12.5 | 26.9 |
| | 1 | 25 | 34.3 33.9 | 27.4 25.9 | 46.0 | 50.8 | 36.5 | 12.5 | 33.3 |
| | 1 1/4 | 32 | 43.1 42.7 | 35.8 34.3 | 55.6 | 65.1 | 44.5 | 12.5 | 33.3 |
| | 1 1/2 | 40 | 49.2 48.8 | 41.6 40.1 | 61.9 | 72.2 | 50.8 | 12.5 | 34.9 |
| | 2 | 50 | 61.7 61.2 | 53.3 51.7 | 74.6 | 88.1 | 65.1 | 16.0 | 39.1 |
| 6000 | 1/2 | 15 | 22.2 21.8 | 12.5 11.0 | 39.7 | 43.7 | 19.1 | 9.5 | 31.8 |
| | 3/4 | 20 | 27.6 27.2 | 16.3 14.8 | 45.2 | 49.6 | 25.4 | 12.5 | 36.6 |
| | 1 | 25 | 34.3 33.9 | 21.5 19.9 | 57.2 | 61.9 | 33.3 | 12.5 | 39.6 |
| | 1 1/4 | 32 | 43.1 42.7 | 30.2 28.7 | 65.1 | 69.1 | 38.1 | 12.5 | 41.3 |
| | 1 1/2 | 40 | 49.2 48.8 | 34.7 33.2 | 76.2 | 82.6 | 49.2 | 12.5 | 42.9 |
| | 2 | 50 | 61.7 61.2 | 43.6 42.1 | 92.1 | 102.4 | 69.9 | 16.0 | 52.3 |

Note : 1) Upper and lower values for each size are the respective maximum and minimum dimensions.
 2) For the CL.3000 and 6000 socketlet, inside bore, socket depth dimensions are according to ASME B16.11
 3) Pipe schedule numbers and weight designations are in accordance with ASME B36.10

All dimensions are in millimeters.

90° Elbow
SLA

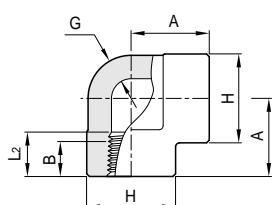

Tee
STA

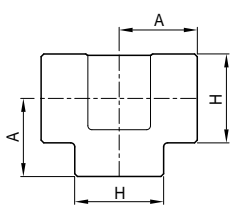

45° Elbow
SLB

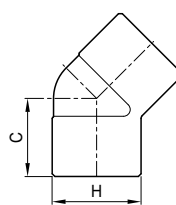
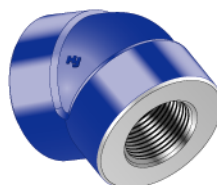

Cross
SXA

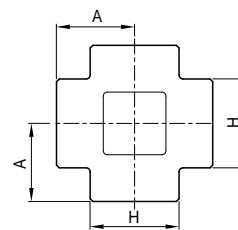
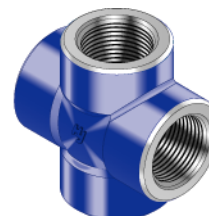

ASME B16.11

| Class Designation of Fittings | Nom. Pipe Size | DN | Center to End Elbows, Tees Crosses A | Center to End 45° Elbows C | Outside Diameter of Band H | Min. Wall Thickness G | Min.Length of Thread ⁽¹⁾ | |
|-------------------------------|----------------|-----|---|-------------------------------|-------------------------------|--------------------------|-------------------------------------|----------------|
| | | | | | | | B | L ₂ |
| 2000 | 1/8 | 6 | 21 | 17 | 22 | 3.18 | 6.4 | 6.7 |
| | 1/4 | 8 | 21 | 17 | 22 | 3.18 | 8.1 | 10.2 |
| | 3/8 | 10 | 25 | 19 | 25 | 3.18 | 9.1 | 10.4 |
| | 1/2 | 15 | 28 | 22 | 33 | 3.18 | 10.9 | 13.6 |
| | 3/4 | 20 | 33 | 25 | 38 | 3.18 | 12.7 | 13.9 |
| | 1 | 25 | 38 | 28 | 46 | 3.68 | 14.7 | 17.3 |
| | 1 1/4 | 32 | 44 | 33 | 56 | 3.89 | 17.0 | 18.0 |
| | 1 1/2 | 40 | 51 | 35 | 62 | 4.01 | 17.8 | 18.4 |
| | 2 | 50 | 60 | 43 | 75 | 4.27 | 19.0 | 19.2 |
| | 2 1/2 | 65 | 76 | 52 | 92 | 5.61 | 23.6 | 28.9 |
| | 3 | 80 | 86 | 64 | 109 | 5.99 | 25.9 | 30.5 |
| 4 | 100 | 106 | 79 | 146 | 6.55 | 27.7 | 33.0 | |

Note : (1) Dimension B is minimum length of perfect thread. The length of useful thread (B plus threads with fully formed roots and flat crests) shall not be less than L₂ (effective length of external thread) required by American National Standard for pipe threads (ASME B1.20.1)

All dimensions are in millimeters.

Forged Fittings

90° Elbow
SLA

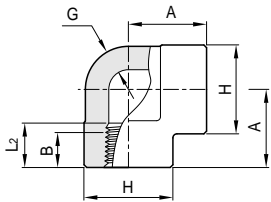

Tee
STA

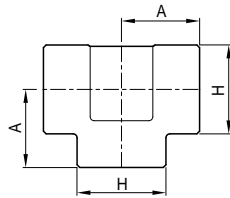

45° Elbow
SLB

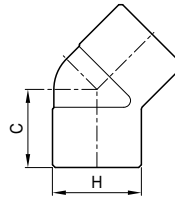
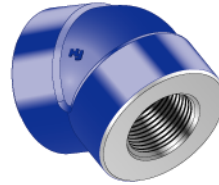

Cross
SXA

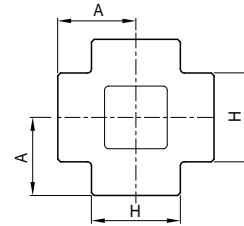
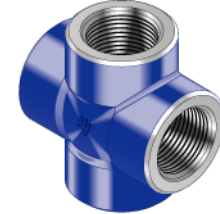

ASME B16.11

| Class Designation of Fittings | Nom. Pipe Size | DN | Center to End Elbows, Tees Crosses A | Center to End 45° Elbows C | Outside Diameter of Band H | Min. Wall Thickness G | Min. Length of Thread ⁽¹⁾ | |
|-------------------------------|----------------|-----|---|-------------------------------|-------------------------------|--------------------------|--------------------------------------|----------------|
| | | | | | | | B | L ₂ |
| 3000 | 1/8 | 6 | 21 | 17 | 22 | 3.18 | 6.4 | 6.7 |
| | 1/4 | 8 | 25 | 19 | 25 | 3.30 | 8.1 | 10.2 |
| | 3/8 | 10 | 28 | 22 | 33 | 3.51 | 9.1 | 10.4 |
| | 1/2 | 15 | 33 | 25 | 38 | 4.09 | 10.9 | 13.6 |
| | 3/4 | 20 | 38 | 28 | 46 | 4.32 | 12.7 | 13.9 |
| | 1 | 25 | 44 | 33 | 56 | 4.98 | 14.7 | 17.3 |
| | 1 1/4 | 32 | 51 | 35 | 62 | 5.28 | 17.0 | 18.0 |
| | 1 1/2 | 40 | 60 | 43 | 75 | 5.56 | 17.8 | 18.4 |
| | 2 | 50 | 64 | 44 | 84 | 7.14 | 19.0 | 19.2 |
| | 2 1/2 | 65 | 83 | 52 | 102 | 7.65 | 23.6 | 28.9 |
| | 3 | 80 | 95 | 64 | 121 | 8.84 | 25.9 | 30.5 |
| 4 | 100 | 114 | 79 | 152 | 11.18 | 27.7 | 33.0 | |

Note : (1) Dimension B is minimum length of perfect thread. The length of useful thread (B plus threads with fully formed roots and flat crests) shall not be less than L₂ (effective length of external thread) required by American National Standard for pipe threads (ASME B1.20.1)

All dimensions are in millimeters.

90° Elbow
SLA

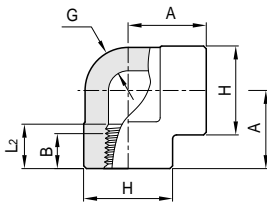

Tee
STA

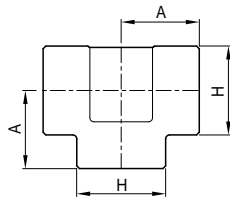

45° Elbow
SLB

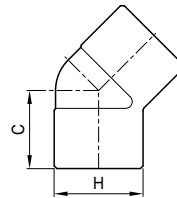
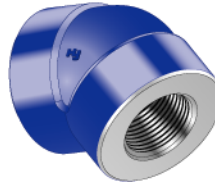

Cross
SXA

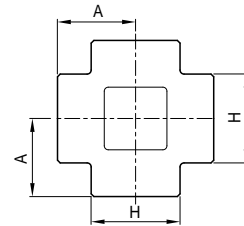
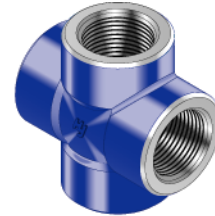

ASME B16.11

| Class Designation of Fittings | Nom. Pipe Size | DN | Center to End Elbows, Tees Crosses A | Center to End 45° Elbows C | Outside Diameter of Band H | Min. Wall Thickness G | Min. Length of Thread ⁽¹⁾ | |
|-------------------------------|----------------|-----|---|-------------------------------|-------------------------------|--------------------------|--------------------------------------|----------------|
| | | | | | | | B | L ₂ |
| 6000 | 1/8 | 6 | 25 | 19 | 25 | 6.35 | 6.4 | 6.7 |
| | 1/4 | 8 | 28 | 22 | 33 | 6.60 | 8.1 | 10.2 |
| | 3/8 | 10 | 33 | 25 | 38 | 6.98 | 9.1 | 10.4 |
| | 1/2 | 15 | 38 | 28 | 46 | 8.15 | 10.9 | 13.6 |
| | 3/4 | 20 | 44 | 33 | 56 | 8.53 | 12.7 | 13.9 |
| | 1 | 25 | 51 | 35 | 62 | 9.93 | 14.7 | 17.3 |
| | 1 1/4 | 32 | 60 | 43 | 75 | 10.59 | 17.0 | 18.0 |
| | 1 1/2 | 40 | 64 | 44 | 84 | 11.07 | 17.8 | 18.4 |
| | 2 | 50 | 83 | 52 | 102 | 12.09 | 19.0 | 19.2 |
| | 2 1/2 | 65 | 95 | 64 | 121 | 15.29 | 23.6 | 28.9 |
| | 3 | 80 | 106 | 79 | 146 | 16.64 | 25.9 | 30.5 |
| 4 | 100 | 114 | 79 | 152 | 18.67 | 27.7 | 33.0 | |

Note : (1) Dimension B is minimum length of perfect thread. The length of useful thread (B plus threads with fully formed roots and flat crests) shall not be less than L₂ (effective length of external thread) required by American National Standard for pipe threads (ASME B1.20.1)

All dimensions are in millimeters.

Street Elbows SLC

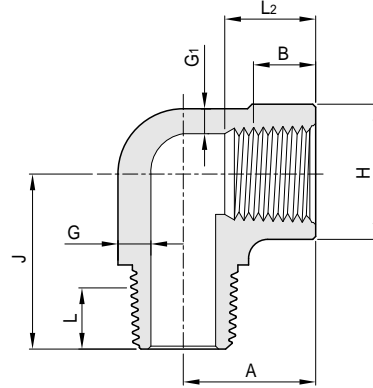

ASME B16.11

| Class Designation of Fittings | Nom. Pipe Size | DN | Center-to-Female End Street Ells A ⁽¹⁾ | Center-to-Male End Street Ells J | Outside Diameter of Band H ⁽²⁾ | Min. Wall Thickness G ₁ | Min. Wall Thickness G ⁽³⁾ | Min. Length Internal Thread ⁽⁴⁾ | | Min. Length Male Thread L |
|-------------------------------|----------------|----|---|----------------------------------|---|------------------------------------|--------------------------------------|--|----------------|---------------------------|
| | | | | | | | | B | L ₂ | |
| 3000 | 1/8 | 6 | 19 | 25 | 19 | 3.18 | 2.74 | 6.4 | 6.7 | 10 |
| | 1/4 | 8 | 22 | 32 | 25 | 3.30 | 3.22 | 8.1 | 10.2 | 11 |
| | 3/8 | 10 | 25 | 38 | 32 | 3.51 | 3.50 | 9.1 | 10.4 | 13 |
| | 1/2 | 15 | 28 | 41 | 38 | 4.09 | 4.16 | 10.9 | 13.6 | 14 |
| | 3/4 | 20 | 35 | 48 | 44 | 4.32 | 4.88 | 12.7 | 13.9 | 16 |
| | 1 | 25 | 44 | 57 | 51 | 4.98 | 5.56 | 14.7 | 17.3 | 19 |
| | 1 1/4 | 32 | 51 | 66 | 62 | 5.28 | 5.56 | 17.0 | 18.0 | 21 |
| | 1 1/2 | 40 | 54 | 71 | 70 | 5.56 | 6.25 | 17.8 | 18.4 | 21 |
| 2 | 50 | 64 | 84 | 84 | 7.14 | 7.64 | 19.0 | 19.2 | 22 | |

- Note :** (1) Dimension A listed on page 21 for the appropriate fitting size may also be used at the option of the manufacturer.
 (2) Dimension H listed on page 21 for the appropriate fitting size may also be used at the option of the manufacturer.
 (3) Wall thickness before threading.
 (4) Dimension B is minimum length of perfect thread. The length of useful thread (B plus threads with fully formed roots and flat crests) shall not be less than L₂ (effective length of external thread) required by American National Standard for pipe threads (ASME B1.20.1)

Street Elbows
SLC

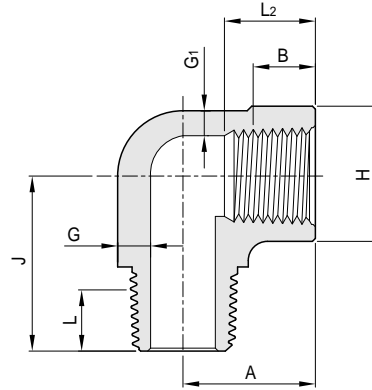

ASME B16.11

| Class Designation of Fittings | Nom. Pipe Size | DN | Center-to-Female End Street Ells A ⁽¹⁾ | Center-to-Male End Street Ells J | Outside Diameter of Band H ⁽²⁾ | Min. Wall Thickness G ₁ | Min. Wall Thickness G ⁽³⁾ | Min. Length Internal Thread ⁽⁴⁾ | | Min. Length Male Thread L |
|-------------------------------|----------------|----|---|----------------------------------|---|------------------------------------|--------------------------------------|--|----------------|---------------------------|
| | | | | | | | | B | L ₂ | |
| 6000 | 1/8 | 6 | 22 | 32 | 25 | 5.08 | 4.22 | 6.4 | 6.7 | 10 |
| | 1/4 | 8 | 25 | 38 | 32 | 5.66 | 5.28 | 8.1 | 10.2 | 11 |
| | 3/8 | 10 | 28 | 41 | 38 | 6.98 | 5.59 | 9.1 | 10.4 | 13 |
| | 1/2 | 15 | 35 | 48 | 44 | 8.15 | 6.53 | 10.9 | 13.6 | 14 |
| | 3/4 | 20 | 44 | 57 | 51 | 8.53 | 6.86 | 12.7 | 13.9 | 16 |
| | 1 | 25 | 51 | 66 | 62 | 9.93 | 7.95 | 14.7 | 17.3 | 19 |
| | 1 1/4 | 32 | 54 | 71 | 70 | 10.59 | 8.48 | 17.0 | 18.0 | 21 |
| | 1 1/2 | 40 | 64 | 84 | 84 | 11.07 | 8.89 | 17.8 | 18.4 | 21 |
| 2 | 50 | 83 | 105 | 102 | 12.09 | 9.70 | 19.0 | 19.2 | 22 | |

- Note :** (1) Dimension A listed on page 22 for the appropriate fitting size may also be used at the option of the manufacturer.
 (2) Dimension H listed on page 22 for the appropriate fitting size may also be used at the option of the manufacturer.
 (3) Wall thickness before threading.
 (4) Dimension B is minimum length of perfect thread. The length of useful thread (B plus threads with fully formed roots and flat crests) shall not be less than L₂ (effective length of external thread) required by American National Standard for pipe threads (ASME B1.20.1)

All dimensions are in millimeters.

Forged Fittings

Full Coupling
SFC

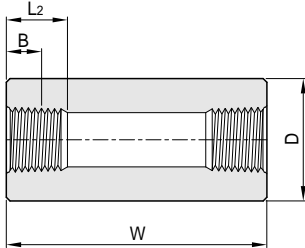

Half Coupling
SHC

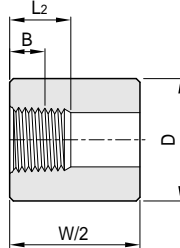
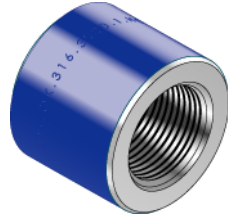

Cap
SCA

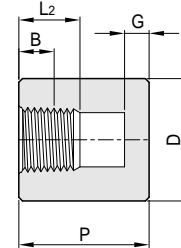
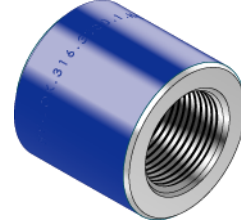

ASME B16.11

| Class Designation of Fittings | Nom. Pipe Size | DN | End-to-End Coupling W | End-to-End Coupling P | Outside Diameter D | End Wall Thickness Min. G | Min.Length of Thread ⁽¹⁾ | |
|-------------------------------|----------------|-----|-----------------------|-----------------------|--------------------|---------------------------|-------------------------------------|----------------|
| | | | | | | | B | L ₂ |
| 3000 | 1/8 | 6 | 32 | 19 | 16 | 4.8 | 6.4 | 6.7 |
| | 1/4 | 8 | 35 | 25 | 19 | 4.8 | 8.1 | 10.2 |
| | 3/8 | 10 | 38 | 25 | 22 | 4.8 | 9.1 | 10.4 |
| | 1/2 | 15 | 48 | 32 | 28 | 6.4 | 10.9 | 13.6 |
| | 3/4 | 20 | 51 | 37 | 35 | 6.4 | 12.7 | 13.9 |
| | 1 | 25 | 60 | 41 | 44 | 9.7 | 14.7 | 17.3 |
| | 1 1/4 | 32 | 67 | 44 | 57 | 9.7 | 17.0 | 18.0 |
| | 1 1/2 | 40 | 79 | 44 | 64 | 11.2 | 17.8 | 18.4 |
| | 2 | 50 | 86 | 48 | 76 | 12.7 | 19.0 | 19.2 |
| | 2 1/2 | 65 | 92 | 60 | 92 | 15.7 | 23.6 | 28.9 |
| | 3 | 80 | 108 | 65 | 108 | 19.0 | 25.9 | 30.5 |
| 4 | 100 | 121 | 68 | 140 | 22.4 | 27.7 | 33.0 | |

General Note : (A) Class 2000 and NPS 1/8 Class 6000 couplings, half couplings, and caps are not included in this standard.

(B) The wall thickness away from the threaded ends shall meet the minimum wall thickness requirements listed on page 21 for the appropriate NPS and Class Designation fitting.

Note : (1) Dimension B is minimum length of perfect thread. The length of useful thread(B plus threads with fully formed roots and flat crests) shall not be less than L₂ (effective length of external thread) required by American National Standard for pipe threads (ASME B1.20.1)

All dimensions are in millimeters.

Full Coupling
SFC

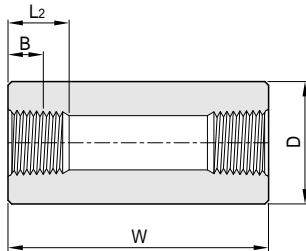

Half Coupling
SHC

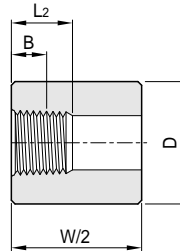
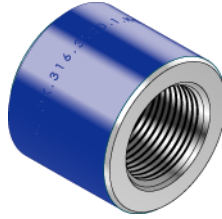

Cap
SCA

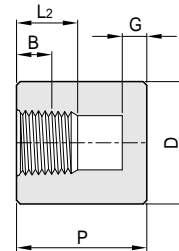
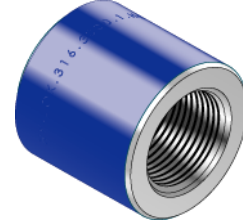

ASME B16.11

| Class Designation of Fittings | Nom. Pipe Size | DN | End-to-End Coupling W | End-to-End Coupling P | Outside Diameter D | End Wall Thickness Min. G | Min.Length of Thread ⁽¹⁾ | |
|-------------------------------|----------------|-----|-----------------------|-----------------------|--------------------|---------------------------|-------------------------------------|----------------|
| | | | | | | | B | L ₂ |
| 6000 | 1/8 | 6 | 32 | - | 22 | - | 6.4 | 6.7 |
| | 1/4 | 8 | 35 | 27 | 25 | 6.4 | 8.1 | 10.2 |
| | 3/8 | 10 | 38 | 27 | 32 | 6.4 | 9.1 | 10.4 |
| | 1/2 | 15 | 48 | 33 | 38 | 7.9 | 10.9 | 13.6 |
| | 3/4 | 20 | 51 | 38 | 44 | 7.9 | 12.7 | 13.9 |
| | 1 | 25 | 60 | 43 | 57 | 11.2 | 14.7 | 17.3 |
| | 1 1/4 | 32 | 67 | 46 | 64 | 11.2 | 17.0 | 18.0 |
| | 1 1/2 | 40 | 79 | 48 | 76 | 12.7 | 17.8 | 18.4 |
| | 2 | 50 | 86 | 51 | 92 | 15.7 | 19.0 | 19.2 |
| | 2 1/2 | 65 | 92 | 64 | 108 | 19.0 | 23.6 | 28.9 |
| | 3 | 80 | 108 | 68 | 127 | 22.4 | 25.9 | 30.5 |
| 4 | 100 | 121 | 75 | 159 | 28.4 | 27.7 | 33.0 | |

General Note : (A) Class 2000 and NPS 1/8 Class 6000 couplings, half couplings, and caps are not included in this standard.

(B) The wall thickness away from the threaded ends shall meet the minimum wall thickness requirements listed on page 22 for the appropriate NPS and Class Designation fitting.

Note : (1) Dimension B is minimum length of perfect thread. The length of useful thread (B plus threads with fully formed roots and flat crests) shall not be less than L₂ (effective length of external thread) required by American National Standard for pipe threads (ASME B1.20.1)

All dimensions are in millimeters.

Forged Fittings

Boss Type A SBA

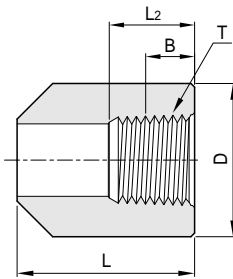
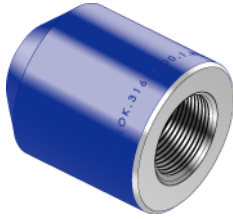

Boss Type R SBR

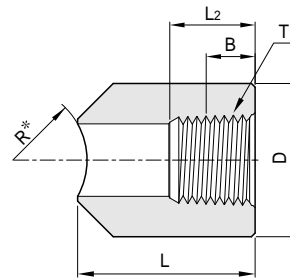
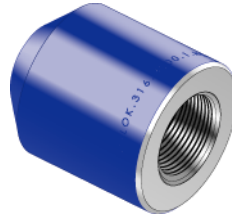

ASME B16.11

| Fittings Pressure Class | Nom. Pipe Size | DN | Outside Diameter D | L | Min. Length of Thread ⁽¹⁾ | |
|-------------------------|----------------|----|--------------------|----|--------------------------------------|----------------|
| | | | | | B | L ₂ |
| 3000 | 1/4 | 8 | 19 | 40 | 8.1 | 10.2 |
| | 3/8 | 10 | 22 | 40 | 9.1 | 10.4 |
| | 1/2 | 15 | 28 | 50 | 10.9 | 13.6 |
| | 3/4 | 20 | 35 | 50 | 12.7 | 13.9 |
| | 1 | 25 | 44 | 50 | 14.7 | 17.3 |
| | 1 1/4 | 32 | 57 | 50 | 17.0 | 18.0 |
| | 1 1/2 | 40 | 64 | 50 | 17.8 | 18.4 |
| 6000 | 2 | 50 | 76 | 60 | 19.0 | 19.2 |
| | 1/2 | 15 | 38 | 50 | 10.9 | 13.6 |
| | 3/4 | 20 | 44 | 50 | 12.7 | 13.9 |
| | 1 | 25 | 57 | 50 | 14.7 | 17.3 |
| | 1 1/4 | 32 | 64 | 50 | 17.0 | 18.0 |
| | 1 1/2 | 40 | 76 | 60 | 17.8 | 18.4 |

Note : * is run pipe sizes

Example : SBR06N-3000-R34 / S316 - 3/4" NPS CL3000 Run pipe 34.0mmO.D

(1) Dimension B is minimum length of perfect thread. The length of useful thread(B plus threads with fully formed roots and flat crests) shall not be less than L₂ (effective length of external thread) required by American national standard for pipe threads (ASME B1.20.1)

All dimensions are in millimeters.

Square Head Plug
H-SPD

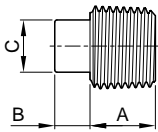
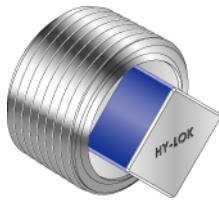

Hex Head Plug
H-SPB

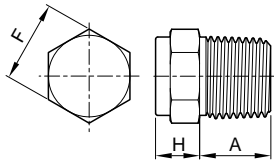
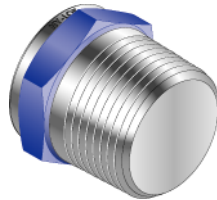

Round Head Plug
H-SPR

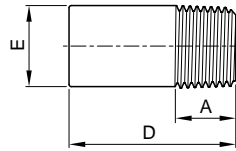
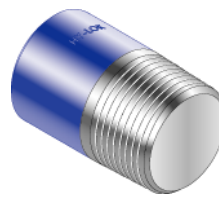

Hex Head Bushing
H-SHB

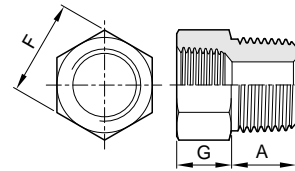
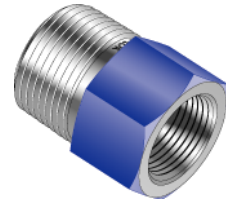

ASME B 16.11

| Nom. Pipe Size | Min. Length A | Square Head Plugs | | Round Head Plugs | | Hex Plugs and Bushings | | |
|----------------|---------------|----------------------|--------------------|----------------------|---------------|------------------------|----------------|--------|
| | | Min. Square Height B | Min. Width Flats C | Nom. Head Diameter E | Min. Length D | Nom. Width Flats F | Hex Height | |
| | | | | | | | Min. Bushing G | Plug H |
| 1/8 | 10 | 6 | 7 | 10 | 35 | 11 | - | 6 |
| 1/4 | 11 | 6 | 10 | 14 | 41 | 16 | 3 | 6 |
| 3/8 | 13 | 8 | 11 | 18 | 41 | 18 | 4 | 8 |
| 1/2 | 14 | 10 | 14 | 21 | 44 | 22 | 5 | 8 |
| 3/4 | 16 | 11 | 16 | 27 | 44 | 27 | 6 | 10 |
| 1 | 19 | 13 | 21 | 33 | 51 | 36 | 6 | 10 |
| 1 1/4 | 21 | 14 | 24 | 43 | 51 | 46 | 7 | 14 |
| 1 1/2 | 21 | 16 | 28 | 48 | 15 | 50 | 8 | 16 |
| 2 | 22 | 18 | 32 | 60 | 64 | 65 | 9 | 18 |
| 2 1/2 | 27 | 19 | 36 | 73 | 70 | 75 | 10 | 19 |
| 3 | 28 | 21 | 41 | 89 | 70 | 90 | 10 | 21 |
| 4 | 32 | 25 | 65 | 114 | 76 | 115 | 13 | 25 |

Note : Cautionary Note Regarding Hex Bushing : Hex head bushings of one-size reduction should not be used in services where they might be subject to harmful loads and forces other than internal pressures.

All dimensions are in millimeters.

Forged Fittings

Union SUR

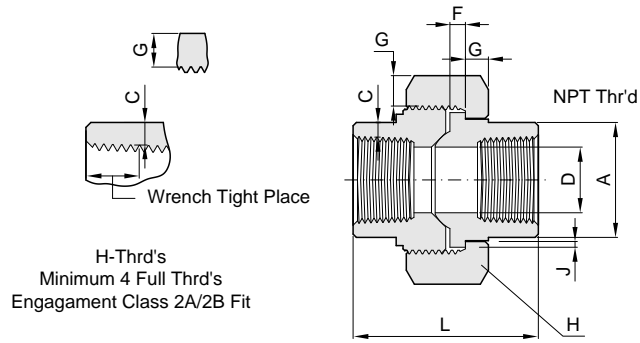
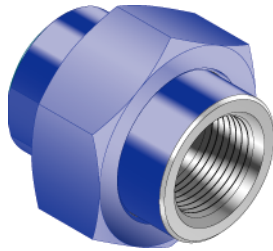

MSS SP-83

| Nom. Pipe Size | DN | Pipe End Min. | Socket Wall Min. | Water Way Bore | Male Flange Min. | Nut Min. | Bearing Min. | Length Assem. Normal | Width Flats |
|----------------|----|---------------|------------------|----------------|------------------|----------|--------------|----------------------|-------------|
| | | A | C | D | F | G | J | L | H |
| 1/8 | 6 | 21.8 | 3.17 | 6.83 6.43 | 3.17 | 3.17 | 1.24 | 41.4 | HEX. 30.0 |
| 1/4 | 8 | 21.8 | 3.30 | 9.85 9.45 | 3.17 | 3.17 | 1.24 | 41.4 | HEX. 36.0 |
| 3/8 | 10 | 25.9 | 3.48 | 13.92 13.51 | 3.43 | 3.43 | 1.37 | 46.0 | HEX. 41.0 |
| 1/2 | 15 | 31.2 | 4.06 | 17.47 17.07 | 3.68 | 3.68 | 1.50 | 49.0 | HEX. 46.0 |
| 3/4 | 20 | 37.1 | 4.27 | 21.79 21.39 | 4.06 | 4.06 | 1.68 | 56.9 | HEX. 55.0 |
| 1 | 25 | 45.5 | 4.95 | 28.14 27.74 | 4.57 | 4.44 | 1.85 | 62.0 | HEX. 60.0 |
| 1 1/4 | 32 | 54.9 | 5.28 | 35.76 35.36 | 5.33 | 5.21 | 2.13 | 71.1 | OCT. 75.0 |
| 1 1/2 | 40 | 61.5 | 5.54 | 41.61 41.20 | 5.84 | 5.59 | 2.31 | 76.5 | OCT. 85.0 |
| 2 | 50 | 75.2 | 6.05 | 52.53 52.12 | 6.60 | 6.35 | 2.69 | 86.1 | OCT. 94.0 |

All dimensions are in millimeters.

Nipple Outlet
SNOL

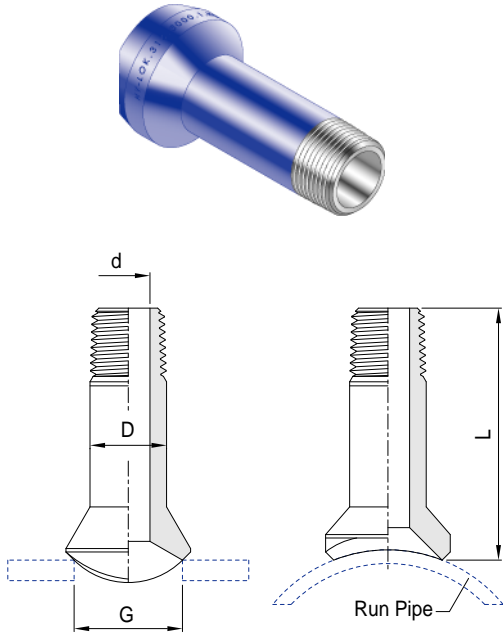

| Nom. Pipe Size | DN | Run Pipe Size | L | G | d | D |
|----------------|----|---------------|------|------|------|------|
| 1/2 | 15 | 36~ 3/4 | 88.9 | 23.9 | 14.0 | 21.3 |
| 3/4 | 20 | 36~ 1 | 88.9 | 30.2 | 18.8 | 26.7 |
| 1 | 25 | 36~1 1/4 | 88.9 | 36.6 | 24.4 | 33.3 |
| 1 1/4 | 32 | 36~1 1/2 | 88.9 | 44.5 | 32.5 | 42.2 |
| 1 1/2 | 40 | 36~ 2 | 88.9 | 50.8 | 38.1 | 48.3 |
| 2 | 50 | 36~2 1/2 | 88.9 | 65.0 | 49.3 | 60.5 |

Plain Nipple Outlet
SPOL

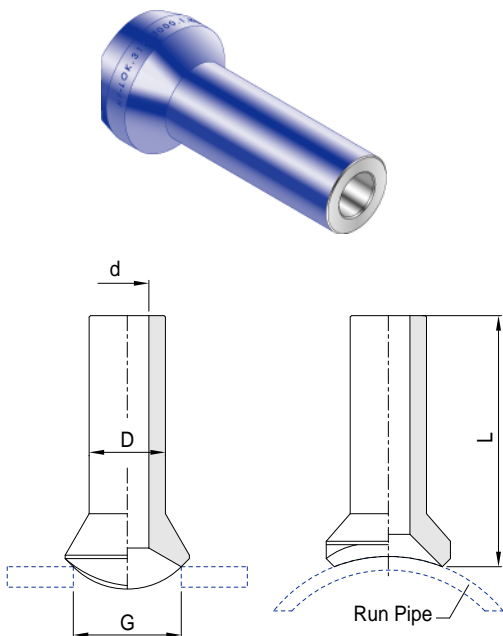

| Nom. Pipe Size | DN | Run Pipe Size | L | G | d | D |
|----------------|----|---------------|------|------|------|------|
| 1/2 | 15 | 36~3/4 | 88.9 | 23.9 | 14.0 | 21.3 |
| 3/4 | 20 | 36~ 1 | 88.9 | 30.2 | 18.8 | 26.7 |
| 1 | 25 | 36~1 1/4 | 88.9 | 36.6 | 24.4 | 33.3 |
| 1 1/4 | 32 | 36~1 1/2 | 88.9 | 44.5 | 32.5 | 42.2 |
| 1 1/2 | 40 | 36~ 2 | 88.9 | 50.8 | 38.1 | 48.3 |
| 2 | 50 | 36~2 1/2 | 88.9 | 65.0 | 49.3 | 60.5 |

Note : XX is Run Pipe Sizes

All dimensions are in millimeters.

Forged Fittings

Swaged Nipple

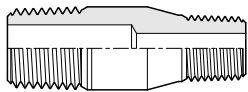

TBE

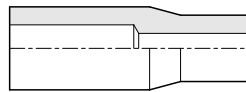

PBE

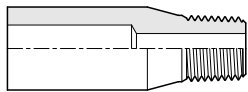

PLE/TSE

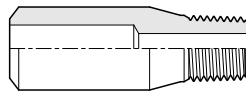

BLE/TSE

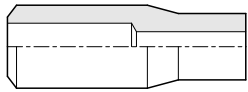

BLE/PSE

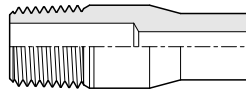

TLE/PSE

MSS-SP-95

| Large end Size | Small end Size | Length |
|----------------|----------------|--------|
| 1/2 | 3/8 - 1/8 | 70 |
| 3/4 | 1/2 - 1/8 | 76 |
| 1 | 3/4 - 1/8 | 89 |
| 1 1/4 | 1 - 1/8 | 102 |
| 1 1/2 | 1 1/4 - 1/8 | 114 |
| 2 | 1 1/2 - 1/8 | 165 |
| 2 1/2 | 2 - 1/8 | 178 |
| 3 | 2 1/2 - 1/8 | 203 |
| 3 1/2 | 3 - 1/8 | 203 |
| 4 | 3 1/2 - 1/8 | 229 |

TBE : Thread both end

PBE : Plain both end

PLE/TSE : Plain large end - thread small end

BLE/TSE : Beveled large end - Thread small end

BLE/PSE : Beveled large end - Plain small end

TLE/PSE : Thread large end - Plain small end

Thredolets
SOL

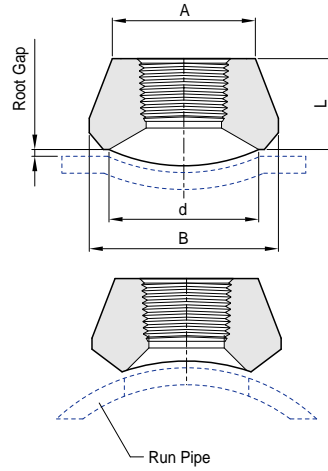
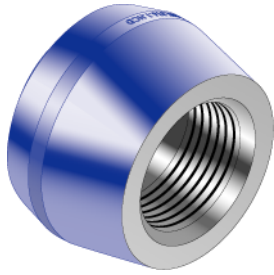

| Class Designation of Fittings | Nom. Pipe Size | A | B | d | L |
|-------------------------------|----------------|------|-------|------|------|
| 3000 | 1/2 | 31.8 | 35.7 | 23.8 | 25.4 |
| | 3/4 | 36.6 | 43.7 | 29.4 | 26.9 |
| | 1 | 46.0 | 50.8 | 36.5 | 33.3 |
| | 1 1/4 | 55.6 | 65.1 | 44.5 | 33.3 |
| | 1 1/2 | 61.9 | 72.2 | 50.8 | 34.9 |
| | 2 | 74.6 | 88.1 | 65.1 | 38.1 |
| 6000 | 1/2 | 39.7 | 43.7 | 19.1 | 31.8 |
| | 3/4 | 45.2 | 49.6 | 25.4 | 36.6 |
| | 1 | 57.2 | 61.9 | 33.3 | 39.6 |
| | 1 1/4 | 65.1 | 69.1 | 38.1 | 41.3 |
| | 1 1/2 | 76.2 | 82.6 | 49.2 | 42.9 |
| | 2 | 92.1 | 102.4 | 69.9 | 52.3 |

Note : • For the CL.3000 and 6000 thredolets , inside bore, thread length dimensions are according to ASME B16.11
 • Pipe schedule numbers and weight designations are in accordance with ASME B36.10

All dimensions are in millimeters.

Forged Fittings

Hex Nipple H-SNA

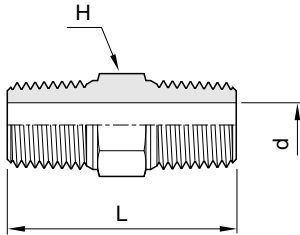
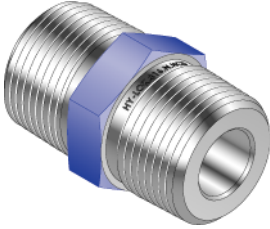

| Nom. Pipe Size | L | d | H Width Across Flat |
|----------------|------|------|---------------------|
| 1/8 | 25.4 | 4.8 | 11.1 |
| 1/4 | 35.3 | 7.1 | 14.2 |
| 3/8 | 36.1 | 9.6 | 17.4 |
| 1/2 | 46.7 | 11.9 | 22.2 |
| 3/4 | 46.7 | 15.7 | 26.9 |
| 1 | 58.7 | 22.3 | 34.9 |
| 1 1/4 | 61.2 | 27.7 | 44.4 |
| 1 1/2 | 67.3 | 34.0 | 50.0 |
| 2 | 73.7 | 46.0 | 65.0 |

Hex Reducing Nipple H-SNR

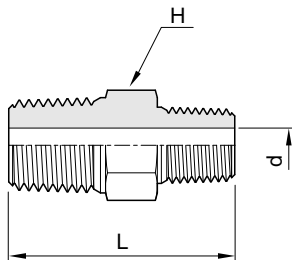
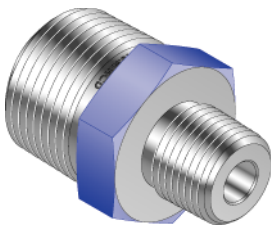

| Nom. Pipe Size | Reduced Nom. Pipe Size | L | d | H Width Across Flat |
|----------------|------------------------|------|------|---------------------|
| 1/4 | 1/8 | 30.7 | 4.8 | 14.2 |
| 3/8 | 1/8 | 32.0 | 4.8 | 17.4 |
| 3/8 | 1/4 | 36.1 | 7.1 | 17.4 |
| 1/2 | 1/8 | 37.2 | 4.8 | 22.2 |
| 1/2 | 1/4 | 41.7 | 7.1 | 22.2 |
| 1/2 | 3/8 | 41.7 | 9.6 | 22.2 |
| 3/4 | 1/4 | 41.7 | 7.1 | 26.9 |
| 3/4 | 1/2 | 46.7 | 11.9 | 26.9 |
| 1 | 1/4 | 49.3 | 7.1 | 34.9 |
| 1 | 1/2 | 54.1 | 11.9 | 34.9 |
| 1 1/4 | 1 | 61.2 | 22.3 | 44.4 |
| 1 1/2 | 1 | 65.8 | 22.3 | 50.0 |
| 2 | 1 | 71.6 | 22.3 | 70.0 |

All dimensions are in millimeters.

Hollow Hex Plug
H-SPA

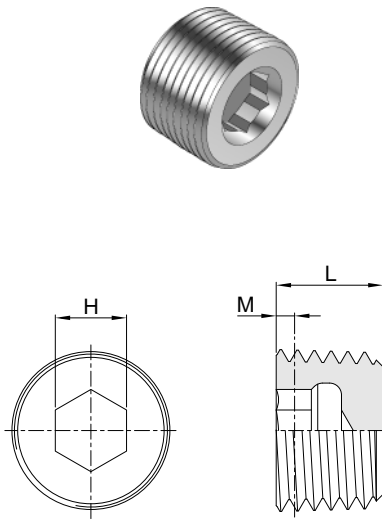

| Nom. Pipe Size | H (HEX.) | L | M |
|----------------|----------|------|------|
| 1/8 | 5 | 7.0 | 0.45 |
| 1/4 | 6 | 9.0 | 0.70 |
| 3/8 | 8 | 10.0 | 0.70 |
| 1/2 | 10 | 12.0 | 0.90 |
| 3/4 | 14 | 14.0 | 0.90 |
| 1 | 17 | 16.5 | 1.10 |
| 1 1/4 | 22 | 19.0 | 1.10 |
| 1 1/2 | 22 | 20.0 | 1.10 |
| 2 | 27 | 22.0 | 1.10 |

Hex Head Plug
H-SPC

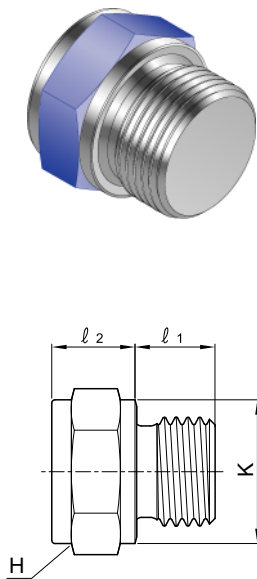

| ISO Parallel Thread | l_1 | l_2 | K | H (HEX.) |
|---------------------|-------|-------|------|----------|
| 1/8 | 7.1 | 11.5 | 13.8 | 14.0 |
| 1/4 | 11.2 | 12.9 | 18.0 | 19.0 |
| 3/8 | 11.2 | 13.8 | 22.0 | 22.0 |
| 1/2 | 14.2 | 16.3 | 26.0 | 27.0 |
| 3/4 | 15.7 | 14.8 | 32.0 | 33.3 |
| 1 | 18.3 | 19.8 | 39.0 | 41.0 |

All dimensions are in millimeters.

Blanking Plugs with *ED-Ring for Ports
DVSTI-GED/MED

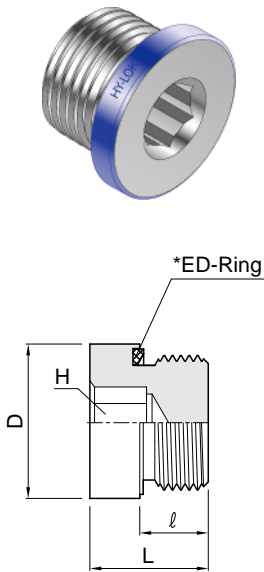

| ISO Metric Thread | ISO Parallel Thread | D | H | L | ℓ |
|-------------------|---------------------|------|----|------|----|
| M 10 x 1 | 1/8 | 14.0 | 5 | 12.0 | 8 |
| M 12 x 1.5 | - | 17.0 | 6 | 17.0 | 12 |
| M 14 x 1.5 | 1/4 | 19.0 | 6 | 17.0 | 12 |
| M 16 x 1.5 | 3/8 | 22.0 | 8 | 17.0 | 12 |
| M 18 x 1.5 | - | 23.9 | 8 | 17.0 | 12 |
| M 20 x 1.5 | - | 25.9 | 10 | 19.0 | 14 |
| M 22 x 1.5 | 1/2 | 27.0 | 10 | 19.0 | 14 |
| M 26 x 1.5 | - | 31.9 | 12 | 21.0 | 16 |
| M 27 x 2 | 3/4 | 32.0 | 12 | 21.0 | 16 |
| M 33 x 2 | 1 | 39.9 | 17 | 22.5 | 16 |
| M 42 x 2 | 1 1/4 | 49.9 | 22 | 22.5 | 16 |
| M 48 x 2 | 1 1/2 | 55.0 | 24 | 22.5 | 16 |

Blanking Plugs with *O-Ring for Ports acc. to ISO 6149 / DIN3852
DVSTI

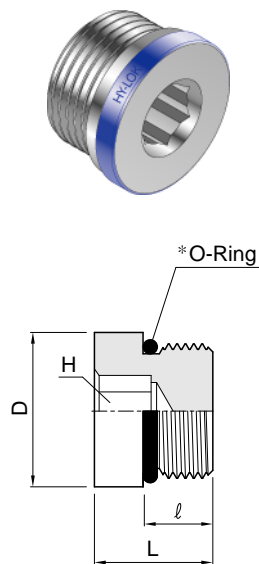

| ISO Metric Thread | D | H | L | ℓ |
|-------------------|----|----|------|------|
| M 10 x 1 | 13 | 5 | 14.0 | 10.0 |
| M 12 x 1.5 | 17 | 6 | 16.5 | 11.5 |
| M 14 x 1.5 | 19 | 6 | 16.5 | 11.5 |
| M 16 x 1.5 | 21 | 6 | 18.0 | 13.0 |
| M 18 x 1.5 | 23 | 8 | 19.5 | 14.5 |
| M 22 x 1.5 | 27 | 10 | 20.5 | 15.5 |
| M 26 x 1.5 | 31 | 12 | 21.0 | 16.0 |
| M 27 x 2 | 32 | 12 | 24.0 | 19.0 |
| M 33 x 2 | 38 | 17 | 25.5 | 19.0 |
| M 42 x 2 | 48 | 22 | 26.0 | 19.5 |

All dimensions are in millimeters.

* The Standard ED-Ring, O-Ring material is NBR(e.g. Perbunan®) however FPM(e.g. Viton®) is also available on request

Seal & Condensate Pot

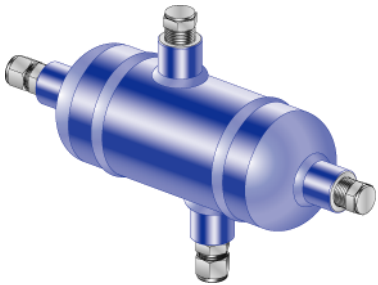
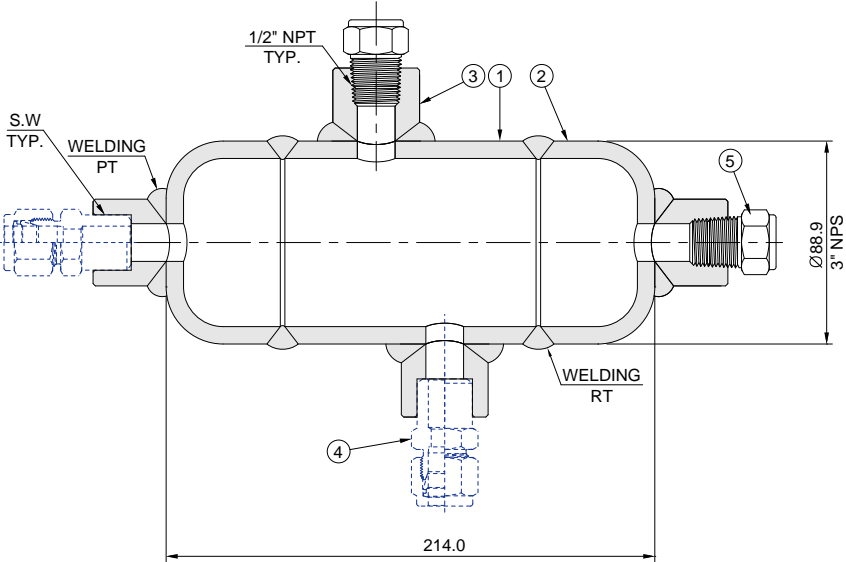

Materials of Constructions

| No. | Description | Materials |
|-----|----------------|-----------------|
| 1 | 3" Pipe | Refer. to below |
| 2 | 3" Cap | Refer. to below |
| 3 | Half Coupling | SS316 or C.S |
| 4 | Weld Connector | SS316 |
| 5 | Hex. Plug | SS316 or C.S |

This drawing is standard specification for part no. ACSPF4NTB

Part Number Designation

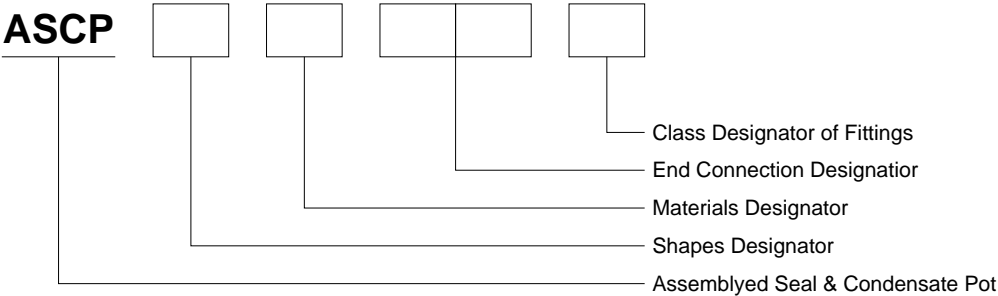

Shapes Designator

| Shapes | Identifier |
|--------|------------|
| | A |
| | B |
| | C |
| | D |
| | E |
| | F |

Materials Designator

| Materials | Identifier |
|-----------------|------------|
| A335 Gr. P11 | 1 |
| A335 Gr. P22 | 2 |
| A106 Gr. B | 3 |
| A312 Gr. TP304 | 4 |
| A312 Gr. TP316 | 5 |
| A312 Gr. TP304L | 6 |
| A312 Gr. TP316L | 7 |

End Connection Designator

| Connection | Identifier |
|-------------|------------|
| 1/2 NPT | N |
| 1/2 PT | R |
| 1/2 S.W | W |
| 1/2" Hy-Lok | T |

Class Designator of Fittings

| Schedule No. | Identifier |
|--------------|------------|
| SCH 40 | A |
| SCH 80 | B |
| SCH 160 | C |
| SCH XXS. | D |

All dimensions are in millimeters.

Dimensions of Welded and Seamless Pipe Carbon, Alloy and Stainless Steel

ASME B36.10M, B36.19M

(in millimeters)

| Nominal Pipe Size (in inches) | Outside Diameter | Nominal Wall Thickness | | | | | | | | |
|-------------------------------|------------------|------------------------|---------|--------|--------|--------|---------|------|--------|--------|
| | | Sch 5S | Sch 10S | Sch 10 | Sch 20 | Sch 30 | Sch 40S | STD | Sch 40 | Sch 60 |
| 1/8 | 10.29 | - | 1.24 | - | - | - | 1.73 | 1.73 | 1.73 | - |
| 1/4 | 13.72 | - | 1.65 | - | - | - | 1.73 | 1.73 | 2.24 | - |
| 3/8 | 17.14 | - | 1.65 | - | - | - | 2.31 | 2.31 | 2.31 | - |
| 1/2 | 21.34 | 1.65 | 2.11 | - | - | - | 2.77 | 2.77 | 2.77 | - |
| 3/4 | 26.67 | 1.65 | 2.11 | 2.11 | - | - | 2.87 | 2.87 | 2.87 | - |
| 1 | 33.40 | 1.65 | 2.77 | 2.77 | - | - | 3.38 | 3.38 | 3.38 | - |
| 1 1/4 | 42.16 | 1.65 | 2.77 | 2.77 | - | - | 3.56 | 3.56 | 3.56 | - |
| 1 1/2 | 48.26 | 1.65 | 2.77 | 2.77 | - | - | 3.68 | 3.68 | 3.68 | - |
| 2 | 60.32 | 1.65 | 2.77 | 2.77 | - | - | 3.91 | 3.91 | 3.91 | - |
| 2 1/2 | 73.02 | 2.11 | 3.05 | 3.05 | - | - | 5.16 | 5.16 | 5.16 | - |
| 3 | 88.90 | 2.11 | 3.05 | 3.05 | - | - | 5.49 | 5.49 | 5.49 | - |
| 3 1/2 | 101.60 | 2.11 | 3.05 | 3.05 | - | - | 5.74 | 5.74 | 5.74 | - |
| 4 | 114.30 | 2.11 | 3.05 | 3.05 | - | - | 6.02 | 6.02 | 6.02 | - |
| 5 | 141.30 | 2.77 | 3.40 | 3.40 | - | - | 6.55 | 6.55 | 6.55 | - |
| 6 | 168.28 | 2.77 | 3.40 | - | - | - | 7.11 | 7.11 | 7.11 | - |
| 8 | 219.08 | 2.77 | 3.76 | - | 6.35 | 7.04 | 8.18 | 8.18 | 8.18 | 10.31 |
| 10 | 273.05 | 3.40 | 4.19 | - | 6.35 | 7.80 | 9.27 | 9.27 | 9.27 | 12.70 |
| 12 | 323.85 | 3.96 | 4.57 | - | 6.35 | 8.38 | 9.52 | 9.52 | 10.31 | 14.27 |
| 14 | 355.60 | 3.96 | 4.78 | 6.35 | 7.92 | 9.52 | - | 9.52 | 11.13 | 15.06 |
| 16 | 406.40 | 4.19 | 4.78 | 6.35 | 7.92 | 9.52 | - | 9.52 | 12.70 | 16.66 |
| 18 | 457.20 | 4.19 | 4.78 | 6.35 | 7.92 | 11.12 | - | 9.52 | 14.27 | 19.05 |
| 20 | 508.00 | 4.78 | 5.54 | 6.35 | 9.52 | 12.70 | - | 9.52 | 15.06 | 20.62 |
| 22 | 588.80 | 4.78 | 5.54 | 6.35 | 9.52 | 12.70 | - | 9.52 | 15.87 | 22.22 |
| 24 | 609.60 | 5.54 | 6.35 | 6.35 | 9.52 | 14.27 | - | 9.52 | 17.48 | 24.61 |
| 26 | 660.40 | - | - | 7.92 | 12.70 | - | - | 9.52 | - | - |
| 28 | 711.20 | - | - | 7.92 | 12.70 | 15.88 | - | 9.52 | - | - |
| 30 | 762.00 | 6.35 | 7.92 | 7.92 | 12.70 | 15.88 | - | 9.52 | - | - |
| 32 | 812.80 | - | - | 7.92 | 12.70 | 15.88 | - | 9.52 | 17.48 | - |
| 34 | 863.60 | - | - | 7.92 | 12.70 | 15.88 | - | 9.52 | 17.48 | - |
| 36 | 914.40 | - | - | 7.92 | 12.70 | 15.88 | - | 9.52 | 19.05 | - |
| 38 | 965.20 | - | - | - | - | - | - | 9.52 | - | - |
| 40 | 1016.00 | - | - | - | - | - | - | 9.52 | - | - |
| 42 | 1066.80 | - | - | - | - | - | - | 9.52 | - | - |
| 44 | 1117.60 | - | - | - | - | - | - | 9.52 | - | - |
| 46 | 1168.40 | - | - | - | - | - | - | 9.52 | - | - |
| 48 | 1219.20 | - | - | - | - | - | - | 9.52 | - | - |

ASME B36.10M, B36.19M

(in millimeters)

| Nominal Wall Thickness | | | | | | | | Outside Diameter | Nominal Pipe Size (in inches) |
|------------------------|-------|--------|---------|---------|---------|---------|-------|------------------|-------------------------------|
| Sch 80S | XS | Sch 80 | Sch 100 | Sch 120 | Sch 140 | Sch 160 | XXS | | |
| 2.41 | 2.41 | 2.41 | - | - | - | - | - | 10.29 | 1/8 |
| 3.02 | 3.02 | 3.02 | - | - | - | - | - | 13.72 | 1/4 |
| 3.20 | 3.20 | 3.20 | - | - | - | - | - | 17.14 | 3/8 |
| 3.73 | 3.73 | 3.73 | - | - | - | 4.75 | 7.47 | 21.34 | 1/2 |
| 3.91 | 3.91 | 3.91 | - | - | - | 5.54 | 7.82 | 26.67 | 3/4 |
| 4.55 | 4.55 | 4.55 | - | - | - | 6.35 | 9.09 | 33.40 | 1 |
| 4.85 | 4.85 | 4.85 | - | - | - | 6.35 | 9.70 | 42.16 | 1 1/4 |
| 5.08 | 5.08 | 5.08 | - | - | - | 7.14 | 10.16 | 48.26 | 1 1/2 |
| 5.54 | 5.54 | 5.54 | - | - | - | 8.71 | 11.07 | 60.32 | 2 |
| 7.01 | 7.01 | 7.01 | - | - | - | 9.52 | 14.02 | 73.02 | 2 1/2 |
| 7.62 | 7.62 | 7.62 | - | - | - | 11.13 | 15.24 | 88.90 | 3 |
| 8.08 | 8.08 | 8.08 | - | - | - | - | 16.15 | 101.60 | 3 1/2 |
| 8.56 | 8.56 | 8.56 | - | 11.13 | - | 13.49 | 17.12 | 114.30 | 4 |
| 9.53 | 9.53 | 9.53 | - | 12.70 | - | 15.88 | 19.05 | 141.30 | 5 |
| 10.97 | 10.97 | 10.97 | - | 14.27 | - | 18.24 | 21.95 | 168.28 | 6 |
| 12.70 | 12.70 | 12.70 | 15.06 | 18.26 | 20.62 | 23.01 | 22.22 | 219.08 | 8 |
| 12.70 | 12.70 | 15.06 | 18.26 | 21.44 | 25.40 | 28.58 | 25.40 | 273.05 | 10 |
| 12.70 | 12.70 | 17.48 | 21.44 | 25.40 | 28.58 | 33.32 | 25.40 | 323.85 | 12 |
| | 12.70 | 19.05 | 23.83 | 27.79 | 31.75 | 35.71 | - | 355.60 | 14 |
| | 12.70 | 21.44 | 26.19 | 30.96 | 36.52 | 40.46 | - | 406.40 | 16 |
| | 12.70 | 23.82 | 29.36 | 34.92 | 39.67 | 45.24 | - | 457.20 | 18 |
| | 12.70 | 26.19 | 32.54 | 38.10 | 44.45 | 49.99 | - | 508.00 | 20 |
| | 12.70 | 28.58 | 34.92 | 41.28 | 47.62 | 53.98 | - | 558.80 | 22 |
| | 12.70 | 30.93 | 38.89 | 46.02 | 52.37 | 59.51 | - | 609.60 | 24 |
| | 12.70 | - | - | - | - | - | - | 660.40 | 26 |
| | 12.70 | - | - | - | - | - | - | 711.20 | 28 |
| | 12.70 | - | - | - | - | - | - | 762.00 | 30 |
| | 12.70 | - | - | - | - | - | - | 812.80 | 32 |
| | 12.70 | - | - | - | - | - | - | 863.60 | 34 |
| | 12.70 | - | - | - | - | - | - | 914.40 | 36 |
| | 12.70 | - | - | - | - | - | - | 965.20 | 38 |
| | 12.70 | - | - | - | - | - | - | 1016.00 | 40 |
| | 12.70 | - | - | - | - | - | - | 1066.80 | 42 |
| | 12.70 | - | - | - | - | - | - | 1117.60 | 44 |
| | 12.70 | - | - | - | - | - | - | 1168.40 | 46 |
| | 12.70 | - | - | - | - | - | - | 1219.20 | 48 |

Dimensions are in millimeters.

American National Standard Taper Pipe Threads : NPT (ANSI : B1.20.1)

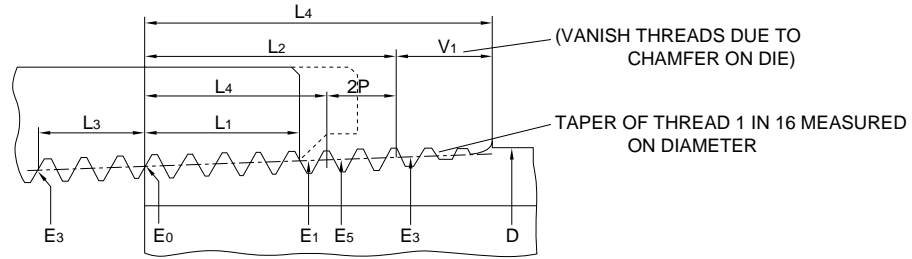

| Nominal Pipe Size | Outside Dia. of Pipe D | Threads per Inch n | Pitch of Thread P | Pitch Diameter at Beginning of External Thread E_0 | Handtight Engagement | | Effective Thread External | |
|-------------------|------------------------|--------------------|-------------------|--|----------------------|------------|---------------------------|------------|
| | | | | | Length L_1 | Dia. E_1 | Length L_2 | Dia. E_2 |
| 1/16 | 0.3125 | 27 | 0.03704 | 0.27118 | 0.1600 | 0.28118 | 0.2611 | 0.28750 |
| 1/8 | 0.4050 | 27 | 0.03704 | 0.36351 | 0.1615 | 0.37360 | 0.2639 | 0.38000 |
| 1/4 | 0.5400 | 18 | 0.05556 | 0.47739 | 0.2278 | 0.49163 | 0.4018 | 0.50250 |
| 3/8 | 0.6750 | 18 | 0.05556 | 0.61201 | 0.2400 | 0.62701 | 0.4078 | 0.63750 |
| 1/2 | 0.8400 | 14 | 0.07143 | 0.75843 | 0.3200 | 0.77843 | 0.5337 | 0.79179 |
| 3/4 | 1.0500 | 14 | 0.07143 | 0.96768 | 0.3390 | 0.98887 | 0.5457 | 1.00179 |
| 1 | 1.3150 | 11 1/2 | 0.08696 | 1.21363 | 0.4000 | 1.23863 | 0.6828 | 1.25630 |
| 1 1/4 | 1.6600 | 11 1/2 | 0.08696 | 1.55713 | 0.4200 | 1.58338 | 0.7068 | 1.60130 |
| 1 1/2 | 1.9000 | 11 1/2 | 0.08696 | 1.79609 | 0.4200 | 1.82234 | 0.7235 | 1.84130 |
| 2 | 2.3750 | 11 1/2 | 0.08696 | 2.26902 | 0.4360 | 2.29627 | 0.7565 | 2.31630 |
| 2 1/2 | 2.8750 | 8 | 0.12500 | 2.71953 | 0.6820 | 2.76216 | 1.1375 | 2.79062 |
| 3 | 3.5000 | 8 | 0.12500 | 3.34062 | 0.7660 | 3.38850 | 1.2000 | 3.41562 |
| 3 1/2 | 4.0000 | 8 | 0.12500 | 3.83750 | 0.8210 | 3.88881 | 1.2500 | 3.91562 |
| 4 | 4.5000 | 8 | 0.12500 | 4.33438 | 0.8440 | 4.38712 | 1.3000 | 4.41562 |
| 5 | 5.5630 | 8 | 0.12500 | 5.39073 | 0.9370 | 5.44929 | 1.4063 | 5.47862 |
| 6 | 6.6250 | 8 | 0.12500 | 6.44609 | 0.9580 | 6.50597 | 1.5125 | 6.54062 |

| Nominal Pipe Size | Wrench Make - up Length for External Thread $L_2 - L_1$ | Wrench Make - up Length for Internal Thread | | Vanish Thread, (3.47 Thds) V | Overall Length External Thread L_4 | Nominal Perfect External Threads | | Height of Thread h | Basic Minor Dia. at Small End of Pipe K_0 |
|-------------------|---|---|------------|------------------------------|--------------------------------------|----------------------------------|------------|--------------------|---|
| | | Length L_3 | Dia. E_3 | | | Length L_5 | Dia. E_5 | | |
| 1/16 | 0.1011 | 0.1111 | 0.26424 | 0.1285 | 0.3896 | 0.1870 | 0.28287 | 0.02963 | 0.2416 |
| 1/8 | 0.1024 | 0.1111 | 0.35656 | 0.1285 | 0.3924 | 0.1898 | 0.37537 | 0.02963 | 0.3339 |
| 1/4 | 0.1740 | 0.1667 | 0.46697 | 0.1928 | 0.5946 | 0.2907 | 0.49556 | 0.04444 | 0.4329 |
| 3/8 | 0.1678 | 0.1667 | 0.60160 | 0.1928 | 0.6006 | 0.2967 | 0.63056 | 0.04444 | 0.5676 |
| 1/2 | 0.2137 | 0.2143 | 0.74504 | 0.2478 | 0.7815 | 0.3909 | 0.78286 | 0.05714 | 0.7013 |
| 3/4 | 0.2067 | 0.2143 | 0.95429 | 0.2478 | 0.7935 | 0.4029 | 0.99286 | 0.05714 | 0.9105 |
| 1 | 0.2828 | 0.2609 | 1.19733 | 0.3017 | 0.9845 | 0.5089 | 1.24543 | 0.06957 | 1.1441 |
| 1 1/4 | 0.2868 | 0.2609 | 1.54083 | 0.3017 | 1.0085 | 0.5329 | 1.59043 | 0.06957 | 1.4876 |
| 1 1/2 | 0.3035 | 0.2609 | 1.77978 | 0.3017 | 1.0252 | 0.5496 | 1.83043 | 0.06957 | 1.7265 |
| 2 | 0.3205 | 0.2609 | 2.25272 | 0.3017 | 1.0582 | 0.5826 | 2.30543 | 0.06957 | 2.1995 |
| 2 1/2 | 0.4555 | 0.2500 | 2.70391 | 0.4337 | 1.5712 | 0.8875 | 2.77500 | 0.10000 | 2.6195 |
| 3 | 0.4340 | 0.2500 | 3.32500 | 0.4337 | 1.6337 | 0.9500 | 3.40000 | 0.10000 | 3.2406 |
| 3 1/2 | 0.4290 | 0.2500 | 3.82188 | 0.4337 | 1.6837 | 1.0000 | 3.90000 | 0.10000 | 3.7375 |
| 4 | 0.4560 | 0.2500 | 4.31875 | 0.4337 | 1.7337 | 1.0500 | 4.40000 | 0.10000 | 4.2344 |
| 5 | 0.4693 | 0.2500 | 5.37511 | 0.4337 | 1.8400 | 1.1563 | 5.46300 | 0.10000 | 5.2907 |
| 6 | 0.5545 | 0.2500 | 6.43047 | 0.4337 | 1.9462 | 1.2625 | 6.52500 | 0.10000 | 6.3461 |

Taper Pipe Threads (JIS B0203 / B0202)

Basic profile of External Taper Thread and Internal Taper Thread

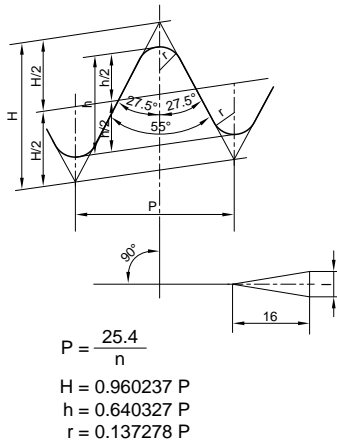

Basic profile of Internal Parallel Thread

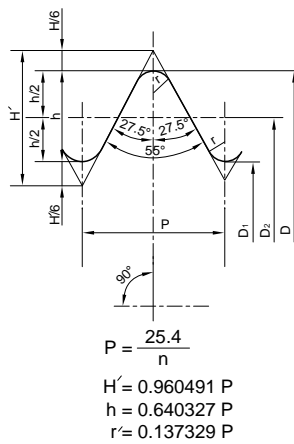

Fit of External Taper Thread to Internal Taper Thread or Internal Parallel Thread

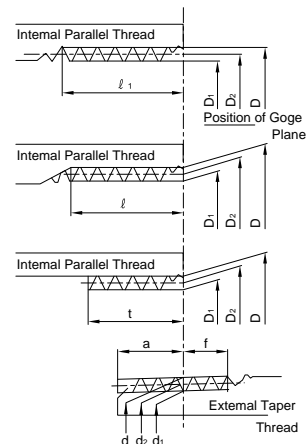

| Nominal Size | Number of Thread per Inch | Screw Thread | | | Basic Diameter | | | Position of Basic Diameter | | | Tolerance on Basic Diameters of Internal Parallel Thread | Effective Thread Length (Min.) | | | | Nominal Pipe Size (For Reference) | | |
|--------------|---------------------------|--------------|------------------|----------|------------------|-------------------------------|-------------------------------|----------------------------|-------------------|-------------------|--|--------------------------------|--|------------------------------------|------------------|-----------------------------------|--------------------------|----------------|
| | | Pitch | Height of Thread | Rounding | External Thread | | | External Thread | | Internal Thread | | Fitting Allowance | Internal Thread | | Outside Diameter | | | Wall thickness |
| | | | | | Major Diameter d | Pitch Diameter d ₂ | Minor Diameter d ₁ | From the End of Pipe | | The End of Pipe | | | When there is an Incomplete thread or More | When there is an Incomplete Thread | | | | |
| | | | | | | | | Basic Length | Tolerance Axially | Tolerance Axially | | | | | | Internal Taper Thread | Internal Parallel Thread | |
| | | n | p | h | r | D | D ₂ | D ₁ | a | ±b | | ±c | ± | f | ℓ | ℓ ₁ | t | |
| R(PT) 1/8 | 28 | 0.9071 | 0.581 | 0.12 | 9.728 | 9.147 | 8.566 | 3.97 | 0.91 | 1.13 | 0.071 | 2.5 | 6.2 | 7.4 | 4.4 | 10.5 | 2.0 | |
| R(PT) 1/4 | 19 | 1.3368 | 0.856 | 0.18 | 13.157 | 12.301 | 11.445 | 6.01 | 1.34 | 1.67 | 0.104 | 3.7 | 9.4 | 11.0 | 6.7 | 13.8 | 2.3 | |
| R(PT) 3/8 | 19 | 1.3368 | 0.856 | 0.18 | 16.662 | 15.806 | 14.950 | 6.35 | 1.34 | 1.67 | 0.104 | 3.7 | 9.7 | 11.4 | 7.0 | 17.3 | 2.3 | |
| R(PT) 1/2 | 14 | 1.8143 | 1.162 | 0.25 | 20.955 | 19.793 | 18.631 | 8.16 | 1.81 | 2.27 | 0.142 | 5.0 | 12.7 | 15.0 | 9.1 | 21.7 | 2.8 | |
| R(PT) 3/4 | 14 | 1.8143 | 1.162 | 0.25 | 26.441 | 25.279 | 24.117 | 9.53 | 1.81 | 2.27 | 0.142 | 5.0 | 14.1 | 16.3 | 10.2 | 27.2 | 2.8 | |
| R(PT) 1 | 11 | 2.3091 | 1.479 | 0.32 | 33.249 | 31.770 | 30.291 | 10.39 | 2.31 | 2.89 | 0.181 | 6.4 | 16.2 | 19.1 | 11.6 | 34.0 | 3.2 | |
| R(PT) 1 1/4 | 11 | 2.3091 | 1.479 | 0.32 | 41.910 | 40.431 | 38.952 | 12.70 | 2.31 | 2.89 | 0.181 | 6.4 | 18.5 | 21.4 | 13.4 | 42.7 | 3.5 | |
| R(PT) 1 1/2 | 11 | 2.3091 | 1.479 | 0.32 | 47.803 | 46.324 | 44.845 | 12.70 | 2.31 | 2.89 | 0.181 | 6.4 | 18.5 | 21.4 | 13.4 | 48.6 | 3.5 | |
| R(PT) 2 | 11 | 2.3091 | 1.479 | 0.32 | 59.614 | 58.135 | 56.656 | 15.88 | 2.31 | 2.89 | 0.181 | 7.5 | 22.8 | 25.7 | 16.9 | 60.5 | 3.8 | |
| R(PT) 2 1/2 | 11 | 2.3091 | 1.479 | 0.32 | 75.184 | 73.705 | 72.226 | 17.46 | 3.46 | 3.46 | 0.216 | 9.2 | 26.7 | 30.1 | 18.6 | 76.3 | 4.2 | |
| R(PT) 3 | 11 | 2.3091 | 1.479 | 0.32 | 87.884 | 86.405 | 84.926 | 20.64 | 3.46 | 3.46 | 0.216 | 9.2 | 29.8 | 33.3 | 21.1 | 89.1 | 4.2 | |
| R(PT) 3 1/2 | 11 | 2.3091 | 1.479 | 0.32 | 100.330 | 98.851 | 97.372 | 22.23 | 3.46 | 3.46 | 0.216 | 9.2 | 31.4 | 34.9 | 22.4 | 101.6 | 4.2 | |
| R(PT) 4 | 11 | 2.3091 | 1.479 | 0.32 | 113.030 | 111.551 | 110.072 | 25.40 | 3.46 | 3.46 | 0.216 | 10.4 | 35.8 | 39.3 | 25.9 | 114.3 | 4.5 | |
| R(PT) 5 | 11 | 2.3091 | 1.479 | 0.32 | 138.430 | 136.951 | 135.472 | 28.58 | 3.46 | 3.46 | 0.216 | 11.5 | 40.1 | 43.5 | 29.3 | 139.8 | 4.5 | |
| R(PT) 6 | 11 | 2.3091 | 1.479 | 0.32 | 163.830 | 162.351 | 160.872 | 28.58 | 3.46 | 3.46 | 0.216 | 11.5 | 40.1 | 43.5 | 29.4 | 165.2 | 5.0 | |



Distributed by :